



XS BRAKE PAD 07067XS

The 07067XS brake pad is synonymous with reliability

Sintered compound specifically for front and rear wheel application on scooters. It is an extremely stable material, guaranteeing consistent performance in all driving situations. It is the ideal material for the latest generation of maxi-scooters

- ✓ OE-equivalent
- ✓ Brembo quality
- ✓ ECE-R90 certificate
- ✓ Safety
- ✓ Comfort

SINTER
BRAKE PADS

07067XS



Technical specifications

Width	Height	Thickness
0 mm	49 mm	6 mm
Compound	Units per box	
Sinter	2	

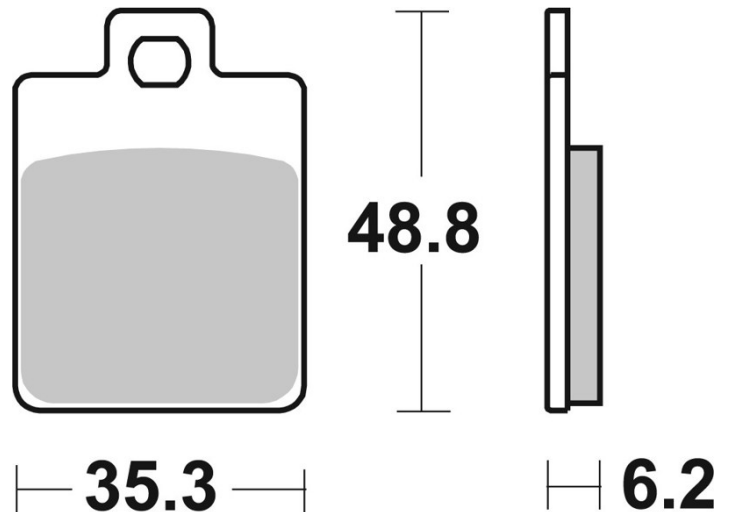

COMPATIBLE VEHICLES