



CC BRAKE PAD 07BB0106

The 07BB0106 brake pad is synonymous with reliability

the evolution of the organic compound, using more carbon. High mileage, excellent hot and cold performance, in dry and wet conditions alike

- ✓ OE-equivalent
- ✓ Brembo quality
- ✓ ECE-R90 certificate
- ✓ Safety
- ✓ Comfort
- ✓ Durability



Technical specifications

Width	Height	Thickness
0 mm	56 mm	7 mm
Compound	Units per box	
Carbon ceramic	2	

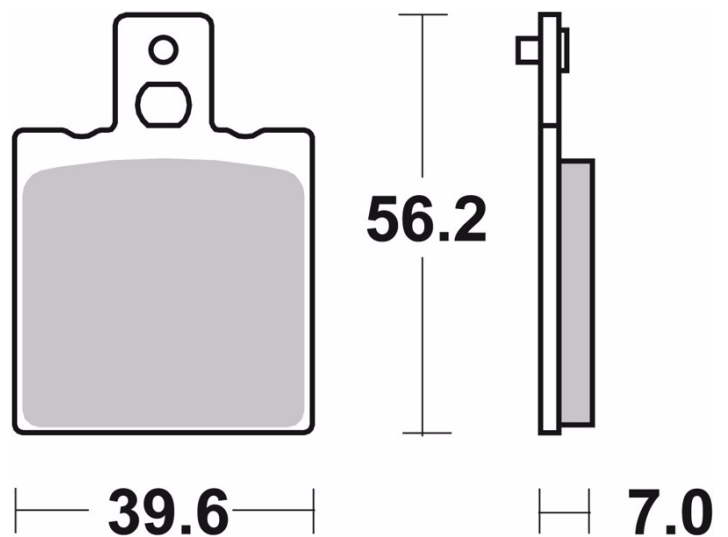

COMPATIBLE VEHICLES