



Krabat Jockey & Jockey Plus

User manual



Safety

All Krabat products are CE marked according to MDR 2017/745 and 93/42 / EØF, Class 1 of 14 June 1993 - Medical Device Directive. This certifies that it meets all relevant European safety requirements. This manual is approved according to these standards. The shelf life of the product corresponds to a lifespan of about 5 years under normal use. After about 5 years the product should be renovated by Krabat AS or an approved partner to extend the product's service life. All service must be performed by Krabat or an authorized partner.

Products with electrical components must be submitted to Krabat for a technical review / overhaul before it is sent out to use again.



The CE-label is to be removed if the product is modified, or non-original parts are used!



Adjustments not described in Krabat user manuals shall only be carried out by Krabat, or by personnel approved by Krabat.



Krabat products are not toys! Improper use may cause damage to both user and/ or the product.



Warranty

Krabat provide a guarantee of 2 years for all products. This guarantee is aimed at defects in workmanship or materials. The guarantee may be reduced or waive if service or daily maintenance are not observed. It is the customer's responsibility to ensure that maintenance is carried out.

The warranty does not cover accidental damage, including damage caused by improper use or lack of maintenance. The warranty does not cover normal wear or wear parts.

The warranty is void if non-original parts are used, or if the product is repaired or modified by personnel not approved by Krabat.

Revision history

Revision	Date	Author	Note
1.0	10.10.2016	A.L. Sørensen	Established
1.1	03.09.2019	Andreas Simensen	Reworked layout, Rev. history added
1.2	12.10.2019	Andreas Simensen	08.0 - Warnings and Definitions added
1.3	03.12.2019	Andreas Simensen	09.0 – Warranty added
1.5	17.10.2020	Andreas Simensen	08.3 - Symbols list updated
1.6	15.04.2021	Andreas Simensen	Revision on front page removed
1.7	20.04.2021	Andreas Simensen	Note on “Tipping” added on page 19
1.8	20.05.2021	Andreas Simensen	Info on “three sizes” added on page 6
1.9	31.05.2021	Andreas Simensen	Revised table “Technical data”
2.0	22.06.2021	Andreas Simensen	05.0 – text on different types of cushions and washing instructions added.

The information in this manual was correct at the time of publication. The information can be changed by the manufacturer without notice, therefore go to www.krabat.no for updated instructions for use and updated technical information about the product at all times.



Jockey & Jockey Plus

01.0. General	s. 05
02.0. Main components	s. 06
03.0. Use	s. 10
04.0. Optional equipment	s. 15
05.0. Maintenance	s. 15
06.0. Individual adjustments	s. 15
07.0. Technical data	s. 16
08.0. Warnings and definitions	s. 17
09.0. Warranty	s. 20





01 - General

This user manual gives an overview of the Krabat Jockey with both electric and manual elevation of the sitting unit. Krabat jockey comes in three different sizes. Many configurations are possible with different accessories.

Krabat Jockey is an active chair for children between the age 9 months – 14 years (3 sizes). The chair is height adjustable and can be adjusted from floor level to the height of a kitchen worktop. The sitting position can be adapted to the individual child. All angles and positions can be set infinitely. An occupational therapist or a physiotherapist should determine the use of this chair.

The excellent sitting position provided by the Krabat jockey is due to both the saddle seat, which promotes a neutral position in the pelvis and abduction in the hips, and the footrests that support the feet in an optimal position.

The chair promotes good stability in the lower body and gives the spinal column natural curves. This provides a good base for balance and activity in the trunk and upper body. The saddle seat enhances an active sitting position rather than a slumped and passive position. The upright and active position will also benefit speech, swallowing and respiration.

To ensure an optimal sitting position it is important to try out and adjust the chair before use. Do not use the chair unless an individual trial has been carried out. Furthermore, do not let other children use the chair without an individual trial.

As children grow they change their movement and sitting pattern on a regular basis. It is likely that the child will need another size of the sitting unit or other adjustments. Contact your local physiotherapist or occupational therapist if the product is not optimal or if adjustments are needed.



Fig. 01

02.0 - Main components -Jockey w/ manual elevation

Krabat Jockey with manual elevation has the following main components:

- 01** Saddle seat with adjustable angle of the sitting unit
- 02** Adjustable backrest
- 03** Adjustable individual footrests or footrest-in-one
- 04** Undercarriage
- 05** Wheels with individual brakes
- 06** Push handle with integrated operation key for elevation
- 07** Central bail



Fig. 02

02.1 - Main components -Jockey w/ electric elevation

Krabat Jockey with electric elevation has the following main components:

- 01 Saddle seat with adjustable angle of the sitting unit
- 02 Adjustable backrest
- 03 Adjustable individual footrests or footrest-in-one
- 04 Undercarriage w/ Control box
- 05 Wheels with individual brakes
- 06 Central bail
- 07 Battery
- 08 Charger
- 09 Power cord



Fig. 03

02.2 - Main components -Jockey Plus w/ manual elevation

Krabat Jockey Plus with manual elevation has the following main components:

- 01** Saddle seat with adjustable angle of the sitting unit
- 02** High backrest with adjustable angle and height
- 03** Adjustable individual footrests or footrest-in-one
- 04** Undercarriage
- 05** Wheels with individual brakes
- 06** Push handle with integrated operation key for elevation
- 07** Central bail
- 08** Adjustable side supports
- 09** Adjustable head support (accessories)
- 10** Harness (accessories)
- 11** 4 mm Allen key for adjustments of head- and side supports is positioned under the seat



Fig. 04

02.3 - Main components -Jockey Plus w/ electric elevation

Krabat Jockey Plus with electric elevation has the following main components:

- 01** Saddle seat with adjustable angle of the sitting unit
- 02** High backrest with adjustable angle and height
- 03** Adjustable individual footrests or footrest-in-one
- 04** Undercarriage w/ Control box
- 05** Wheels with individual brakes
- 06** Push handle with integrated operation key for elevation
- 07** Central bail
- 08** Adjustable side supports
- 09** Adjustable head support (accessories)
- 10** Harness (accessories)
- 11** 4 mm Allen key for adjustments of head- and side supports is positioned under the seat
- 12** Battery
- 13** Charger
- 14** Power cord



03.0 - Use

To obtain the optimal sitting position the angles of the seat, backrest and footrest need to be adjusted. This should be done by a therapist who has received training from Krabat AS, or a representative for Krabat AS.

All angles can be adjusted infinitely. The individual footrests can be adjusted by loosening the 4 screws shown in fig. 05. The footrest-in-one can be adjusted using two screws shown in fig. 06. The sitting unit can be adjusted using the turnbuckle shown in fig. 07. The angle of the backrest can be fixed in different positions using the locking lever shown in fig. 08.

The use of the chair should be discussed with your therapist or someone who knows the child well. It is important to establish in which situations the child should use the chair, how long they should use it and when to progress the time spell. This needs to be evaluated continuously as the child gets familiar with the chair.

03.1 - Individual footrests

Place the feet on the footrests and tighten the belts. Children who use ankle-foot orthotics should wear these, together with their shoes, whilst sitting in the Krabat Jockey. The height of the footrests is adjusted by sliding them up or down the tracks, or simply by adjusting the length of the strap which is attached underneath the seat. It is also possible to attach ankle straps on the footrests. These will need adjustment to ensure the child's foot is in the correct position.

Fig. 05
Adjustment of individual footrests



03.2 - Footrest-in-one

The height of the footrests is adjusted by sliding them up or down the tracks, or simply by adjusting the length of the strap which is attached underneath the seat. It is also possible to attach ankle straps on the footrest. These will need adjustment to ensure the child's foot is in the correct position.

Fig. 06
Adjustment of footrest-in-one



03.3 - Angle of the sitting unit

Place the child on the saddle seat and tighten the hip belt. Make sure the child is placed well into the seat in the midline position with symmetry in the legs / lower body. Use the hip belt to both maintain the position in the saddle seat and to reduce the risk of falling out of the chair. The hip belt should be used at all times when Krabat jockey is in use. The angle of the sitting unit can be adjusted using the turnbuckle underneath the seat. The angle is self locking and does not need to be fixed.

Fig. 07

Adjustment of the seat angle using the turnbuckle



Note: The turnbuckle has a spring loaded plunger functioning as a mechanical end stop.

If the end stop is engaged when increasing the seat angle, it has to be released if seat angle is to be decreased. Release the end stop by pulling the plunger and turn the adjusting tube on the turnbuckle to adjust the seat angle.

Fig. 08

Turnbuckle end stop plunger



03.4 - Angle and height of backrest

The angle of the backrest can be adjusted and fixed using the locking lever. If the locking lever does not fix the backrest properly, it can be tightened adjusting the plastic ring under the lever. The height of the backrest can be adjusted by loosening the locking lever before sliding the backrest up or down in 5 different position, each with 1 cm interval. Remember to fix or tighten the locking lever when you have achieved the correct height.

Fig. 09

Adjustment of the angle and height of the backrest



03.5 - Adjustment of the side supports - Jockey Plus

The side supports can be adjusted up or down by loosening the screws shown in figure 09. It is enough to loosen the screws, dismantling is not required. Tighten the screws after adjustment.

The side supports can be adjusted in or out in the same way.



Fig. 10
Adjustment of the side supports

03.6 - Adjustment of the height - Electric elevation

The adjustment of the height is controlled by the remote control. The remote control, shown in figure 10, has one button for elevation and one for lowering. As soon as you let go of the button, the movement will stop. A beeping sound will be heard when the sitting unit is in the highest or lowest position, to let us know the sitting unit has reached the end position.

If a beeping sound is heard whilst the sitting unit is moving up or down, the battery needs charging.



Fig. 11
Electrical adjustment of height

Note: When a user is seated in the chair and the chair must be moved, e.g. from room to room, it is recommended NOT to do this with the seat in the highest position (!)

To prevent the chair from accidentally tipping, never move the chair with the seat in the uppermost position.

03.7 - Battery and charging unit

The Control box is located under the under-carriage as described in figure 2. When a battery is inserted into the Control box, an audible beep indicates good connection and the chair is ready for use. When a fully charged battery is inserted there are magnets in the battery to ensure the correct position in both holder and charger. If a beeping sound is heard whilst the chair is not in use, the battery needs charging. The same applies if a beeping sound is heard whilst the sitting unit is moving up or down.

To charge the battery, remove it from the Control box and insert it into the supplied charger cradle, connect the cradle to the charger and connect the charger to supply mains using the power cord. When connecting the charger to a socket using the power cord, a yellow light will indicate power. Refer to fig. 12: A flashing green light will indicate the battery being charged. When the battery is fully charged the green light will glow continuously.

Charging an empty battery will take approximately 5-8 hours. This type of battery (NiMH) tolerates charging even if it is not totally discharged.

If the battery runs empty during operation, remove battery for recharging. The chair's elevation will not work with an empty battery (or without a battery at all), but the chair is still safe to use.



Indicator LED



Fig. 12
Charging of the battery

Charger

Note: Always place the charger in a safe and easy accessible location when charging the battery, to ensure swift disconnection from supply mains if a problem should occur during the charging process.

To disconnect the charger from supply mains, simply disconnect the power cord plug from the wall socket, or unplug the appliance coupler from the battery charger.

Only use Mascot Type 2215 battery charger that is supplied with the product (!)

Damaged or malfunctioning battery is disposal waste, please recycle.

Note: The battery is unique for appliances from Krabat, only OEM batteries can be used. Failing to do so, the warranty no longer applies.

Warning: As a precaution, to prevent the risk of pinching or entrapment, remove battery when the Krabat Jockey is not in use.

04.0 – Accessories

There is a wide range of accessories available for the Krabat Jockey such as table, head support and push bar. There are also a variety of different harnesses, ankle cuffs, bags, etc. available. See www.krabat.com for an updated list of accessories.

All accessories come with their own user manual.

If you need accessories or other equipment for your Krabat Jockey chair, please contact a Krabat representative, or a Krabat-approved therapist for installation and adjustment.

05.0 - Maintenance

All metal and plastic parts can be cleaned using mild soapy water. The seat and backrest is covered with different types of upholstery, either an “all-in-one” cushion or a cushion with separate seat cover. The “all-in-one” cushion may be cleaned using a cloth and soapy water or machine washed at 40 degrees Celsius. The separate seat cover may be machine washed at 40 degrees Celsius. None of the cushions or seat covers can be tumble dried.

This is a personal product, individually customized according to medical requirements and demands from each user. No regular maintenance is required.

Wash the chair’s components when needed. Follow normal hygiene advice and keep the chair clean and tidy at all times.

The textile is fastened to the chair with Velcro. Advice about spot removal is given at www.krabat.com.

Bearings and other movable parts are maintenance free and should not be lubricated.

To prevent injury, no part of the product shall be serviced or maintained while in use.

NOTE: If any part should break or is obviously damaged, please stop using the chair and contact authorized personnel for service or appropriate corrective measures.

06.0 - Individual adjustments and adaptations

If the sitting unit for some reason needs adjustment, please contact a physiotherapist or an occupational therapist. Adaptations of the sitting unit must be made by qualified personnel or Krabat AS.

Do not under any circumstances make any modifications by yourself.

07.0 - Technical data

Description	Size 0	Size 1	Size 2
Seat depth	32 cm	28 cm	34 cm
Seat width	23 cm	25 cm	32 cm
Backrest angle	Fixed 90 degrees	Fixed 90 degrees	Fixed 90 degrees
Seat angle/tilt	-20 degrees til +20 degrees	-20 degrees til +20 degrees	-20 degrees til +20 degrees
Avstand seat to footrest	15 to 40 cm	15 to 40 cm	25 to 50 cm
Seat height	39 to 79 cm	39 to 79 cm	40 to 80 cm
Total length in use /collapsed	68 cm / 65 cm	68 cm / 65 cm	98 cm / 83 cm
Total height in use /collapsed	112 cm / 63 cm	112 cm / 63 cm	121 cm / 72 cm
Total width in use /collapsed	63 cm / 63 cm	63 cm / 63 cm	66 cm / 66 cm
Backrest width	20 cm	25 cm	32 cm
Backrest height	25 - 30 cm	35 - 38 cm	40 - 43 cm
Weight manual / electric	12.0 kg / 13.7 kg	12.2 kg / 13.9 kg	15.0 kg / 16.7 kg
User age	Ca 9 months - 2 yrs	Ca 2 - 7 years	Ca 7 - 14 years
Max user weight manual/ electric	65 kg / 50 kg	65 kg / 50 kg	65 kg / 50 kg

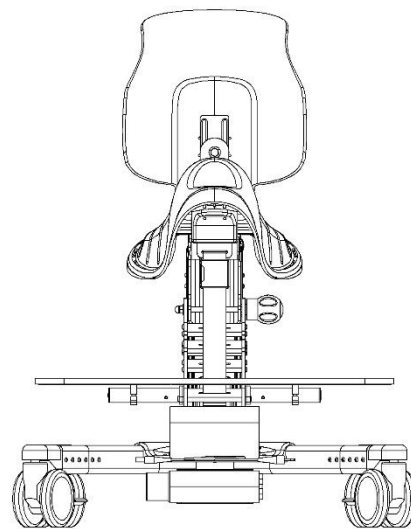
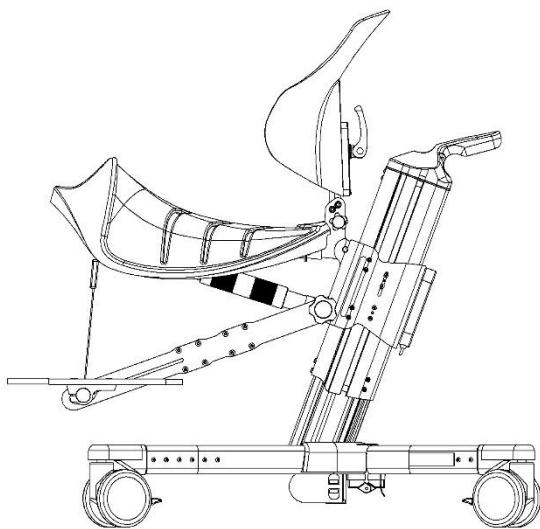

08.0 – Troubleshooting.

If you experience any electrical problems with the Krabat Jockey, e.g. no elevation of the seat unit, or any unexpected stops when in use, please do the following:

If elevation doesn't work:

- Check that a battery is inserted into the Control box
- Check that the battery is correctly inserted
- Check battery charging status
- Check that both cables are inserted into Control box
- Check that the Hand control is properly connected to the Control box
- Check cables for cuts or kinks

If battery is low on voltage or discharged, please charge battery (see 03.7, page 14).

If elevation stops working when in use:

- Check for audible alarm (beep) that indicates low battery voltage
- Check that the battery is correctly inserted
- Check battery charging status
- Check that all cables are in good condition and properly connected

Make sure the battery is fully charged and inserted correctly into the Control box before use. If you experience a shutdown and have gone through all necessary steps above, and the elevation on the Krabat Jockey still doesn't work, please contact Krabat or a Krabat representative to get the problem fixed.

Note: If you experience a shutdown and the Krabat Jockey's elevation doesn't work, it is still safe to use the Krabat Jockey if the battery is removed.

Note: Without battery or functional elevation there is no way to alter the height of the seat. As a precaution, to reduce risk of pinching or entrapment, you can remove the battery when the chair is not in use.

General troubleshooting: If any part should break or is obviously damaged, please stop using the chair and contact Krabat or authorized personnel for service or appropriate corrective measures.

09.0 – Warnings and definitions

General warnings:

Suffocation/ strangulation: During normal use, when Intended user is seated and secured, there are no strangulation- or entrapment hazards. If the Intended user is not seated and is located near the hand control and its cable, there is a possibility of suffocation. To avoid possible suffocation hazard, never leave a child unattended with the Krabat Jockey.

Entrapment/ pinching: If someone should be located close to the main column when in use, there is a possibility of entrapment or pinching. To reduce the possibility of incidents regarding entrapment or pinching, make sure no one is located close to the main column when in use. To further prevent the possibility of incidents, never leave the chair unattended. To avoid possible entrapment hazard, the battery can be removed as a second control measure.

Tipping: If excessive load is applied to the table or the footrest this may contribute to make the chair unstable and increases the risk of the chair to tip forwards. As a precaution, to avoid the possibility of tipping, make sure no foreign objects are placed on table or footrest when in use.

Battery: The battery is of a Li-Fe type. It is easy to use and to maintain and is regarded harmless if handled according to the manufacturer's instructions. To avoid the possibility of injury related to the use- or maintenance of the battery, never leave a child with the chair unattended. See 03.7 page 15 for further details.

Applied parts definition:

Applied parts are defined as parts of the product that come in contact with the USER during normal use / to perform its function.

Applied parts are defined as: Seat and backrest including cushions, foot support(s) including foot straps and hip belt if applied: head rest, table and push bar.

Electro magnetic disturbance definition:

Electro Magnetic Compatibility (EMC) indicates unintentional generation, propagation and reception of electromagnetic energy which may cause unwanted effects. Electromagnetic interference might occur and cause the unit to behave in an unwanted way.

To prevent exposure to unwanted EMC, please take the following precautions:

1. Do NOT stack the equipment close to other equipment that might emit/ immerse EMC
2. Portable RF equipment should NOT be used closer than 30cm to the chair
3. Use of other accessories than recommended by the manufacturer may result in unwanted EMC properties

If the chair should be exposed to unwanted electro magnetic disturbance, chair may malfunction and unexpected movement may occur. Probability of harm to the user is minimal.

In case user/ assistance experience irregular movement/ loss of essential performance, precautions may be:

- Stop using unit
- Relocate the unit

- Increase separation
- Consult the manufacturer representative

Emission test	Limits
Conducted emission	CISPR 11
Radiated Emission	CISPR 11
Harmonic distortion	IEC 61000-3-2
Flicker	IEC 61000-3-2

Immunity test	Level
Electrostatic discharge (ESD)	± 8 kV contact ± 2 kV, ± 4 kV, ± 8 kV, ± 15 kV air
Radiated RF EM field	10 V/m, 80 MHz – 2.7 GHz
Proximity field to RF wireless communication equipment	9 to 28 V/m
Radiated power frequency magnetic fields	30 A/m, 50 and 60 Hz
Electrical fast transients / burst	± 2 kV, 100 kHz repetition frequency
Surges, Line to line	± 0.5 kV, ± 1 kV
Conducted disturbances induced by RF fields	3 V, 0.15 MHz to 80 MHz, 6 V in ISM and amateur bands between 0.15 MHz and 80 MHz.
Voltage dips	0 % U _T ; 0.5 cycle at 0°, 45°, 90°, 135°, 180°, 225°, 270° and 315° 0 % U _T ; 1 cycle 70 % U _T ; 25/30 cycles at 0°
Voltage interruptions	0 % U _T ; 250/300 cycle

Power source - definition:

The Krabat Jockey is battery powered and is defined as “internally powered”.

IP rating - definition:

IP ratings, or “**Ingress Protection**” are defined in international standard EN 60529/ IEC 60509:1989. These standards are used to define levels of sealing effectiveness of electrical enclosures against intrusion from foreign bodies (tools, dirt etc) and moisture.

This product is rated IP22.

IP22 explained:

The first digit describes the grade of intrusion that is allowed for this product, the second digit describes the grade of moisture intrusion that is allowed. Broken down this means:

First digit (2) - Protection against fingers or other object not greater than 80mm in length and 12mm in diameter (accidental finger contact)

Second digit (2) - Protection against water droplets deflected up to 15° from vertical

09.1 – Environmental conditions for transport and storage

When in transit and/ or in storage, the Krabat Jockey should remain operational in normal use within its specifications after transport or storage in the following environmental temperature range:

- -25 °C to +5 °C, and
- +5 °C to +35 °C at a relative humidity up to 90%, non-condensing;
- >35 °C to 70 °C at a water vapour pressure up to 50 hPa

after having been removed from its packaging and subsequently between uses.

Note: It is recommended that the Krabat Jockey should be stored indoors.

09.2 – Environmental conditions for use

When in use, the Krabat Jockey should be operated under the following environmental operating conditions:

- a temperature range of + 5 °C to + 40 °C;
- a relative humidity range of 15 % to 93 %, non-condensing; and
- an atmospheric pressure range of 700 hPa to 1 060 hPa

This product is classified for non-continuous operation.

Normal duty cycle for use – 10% or 2 minutes operation followed by 18 minutes standstill.

Use after storage:

If the Krabat Jockey comes directly from a cold storage room (below 0C), please wait 20 minutes before using the chair.

If the Krabat Jockey is stored in a very hot place (above 50C), please allow all surfaces to cool down to ambient temperature before seating the child. Please wait 20 minutes before using the chair.

Avoid burn/ scalding:













If the Krabat Jockey is left in direct sunlight, please move the chair away from direct sunlight and check that all surfaces of the chair maintain an acceptable temperature before seating the child.

Tip: To avoid that the surfaces become too hot, the Krabat Jockey can be covered with a blanket to shield surfaces of the chair from direct sunlight.

Recycle components and materials in accordance with local, state, and national regulations.

09.3 – Symbols, description/ explanation

The different symbols used on product and in this User Manual explained below

Symbol	Description	Meaning	Explanation
	Symbol for use in the labelling of medical devices.	Manufacturer	Indicates the medical device manufacturer.
	Medical electrical equipment — Part 1: General requirements for basic safety and essential performance.	Consult instructions for use	Indicates the need for the user to consult the instructions for use.
	Medical electrical equipment — Part 1: General requirements for basic safety and essential performance	Follow instructions for use	Refer to instruction manual/booklet.
	General warning sign	Attention: Read all warnings and precautions in instructions for use	<i>When a user is seated in the chair and the chair must be moved, e.g. from room to room, it is recommended NOT to do this with the seat in the highest position (!) To prevent the chair from accidentally tipping, never move the chair with the seat in the uppermost position.</i>
	Medical electrical equipment —	Type BF applied part	To identify a type BF applied part complying with IEC 60601-1.
IPN ₁ N ₂	Medical electrical equipment — Part 1: General requirements for basic safety and essential performance.	Degree of Ingress Protection Provided by Enclosure	Manufacturer-determined degree of particle and water ingress protection.
	Symbol for use in the labelling of electrical devices.	In-door use only	To identify electrical equipment designed primarily for indoor use.
	Symbols for use in the labelling of electrical devices.	Class II equipment	To identify equipment meeting the safety requirements specified for Class II equipment
	The requirements for accreditation and market surveillance relating to the marketing of products; Medical Device Directive.	CE marking	Signifies European technical conformity.
	Symbol for use in the labelling of electrical devices.	Do not throw in general waste	Highlights that you should not place the electrical item in the general waste (it should be taken to a local recycling centre)
	Symbol from the certified body that performed tests	Certification mark	Certification mark that signifies that this product is certified to meet requirements of US and Canadian electrical safety standards.
	Safety sign to prohibit sitting on a surface.	No sitting on surface	To identify surfaces/ parts that are unsuitable to sit on.
	Safety sign to prohibit stepping onto a surface.	No stepping on surface	To identify surfaces/ parts that are unsuitable to step on.

10.0 - Warranty

Manufacturer of the Krabat products, Krabat AS – hereinafter referred to as KRABAT - having its place of business at Ravnsborgveien 56, 1395 Hvalstad, Asker, Norway – gives the purchaser of a KRABAT product the following product warranty, hereinafter referred to as the “WARRANTY”:

1. This WARRANTY is given upon the strict condition that the purchaser and any person that the purchaser gives access to the KRABAT product observe and adhere to the following SAFETY PRECAUTIONS:
 - I. Always make sure to have read and understood the relevant user manual for the actual KRABAT product before taking into it use.
 - II. The KRABAT product is only meant to be used for its intended purpose in accordance with the KRABAT user manual for the relevant KRABAT product.
 - III. Never leave a child, or any other user, using the KRABAT product without proper adult supervision.
 - IV. Always make sure that safety belts are properly fit and fastened and do not malfunction, as well as recheck the foresaid at regular intervals when the KRABAT product is in use.
 - V. Always use the KRABAT product with due regard to the advice of your physiotherapist or occupational therapist.
 - VI. Always remember that the KRABAT product is NOT a toy, and hence, never let a child, or any one else, play with the KRABAT product, as it can harm both persons and the product as well as causing damage.
 - VII. Always – when not in use - store the KRABAT product in a safe manner in order for it not to be misused by anyone, and furthermore for the purpose of not exposing the KRABAT product to conditions that may harm it and/or its functions.
2. Subject to the terms and conditions of the WARRANTY, KRABAT warrants that the KRABAT product for a period of one (1) year (“the Warranty Period”) from the purchase of the KRABAT product, shall function in accordance with its intended purpose as set out in the KRABAT user manual following the actual KRABAT product purchased.
3. KRABAT will at its own cost either itself, or by assistance of a third party, within reasonable time offer assistance in order to remedy any defect of substance to the KRABAT product which occurs within the said Warranty Period, either by taking the unit in question for repair or by forwarding spares for replacement, provided, however, the purchaser of the KRABAT product without undue delay after having become aware of the defect(s), in writing has notified KRABAT or a representative authorized by KRABAT of the discovered defect(s). However, KRABAT retains the right at its sole discretion in lieu of performing remedial work to forward a new unit in lieu of the unit having defects or being defective. In respect of forwarding spare or replacement parts, or a new unit, KRABAT or its authorized representative, shall be deemed to have fulfilled its obligation in so far the part(s) or unit(s) in question are made available for collection at the offices from where the initial KRABAT product was sold.
4. In the event where a defect has not been successfully remedied,
 - I. I The purchaser shall be entitled to a reduction of the purchase price in proportion to the reduced value of the KRABAT product, provided that under no circumstances shall such reduction exceed fifteen per cent (15 %) of the purchase price for the said KRABAT product, or

- II. II Where the defect is so material as to significantly deprive the purchaser of the benefit of the purpose of the purchase, the purchaser may terminate the purchase in respect of the defective KRABAT product. The purchaser shall then be entitled to actual loss suffered, if any, however, limited to a maximum of fifteen per cent (15 %) of the purchase price for the said KRABAT product.
5. This WARRANTY does not give any guarantees apart from those expressly given under this WARRANTY.
 6. For avoidance of doubt This WARRANTY does not extend to any liability of KRABAT or its authorized representatives in respect of any indirect or consequential loss or damage suffered by the purchaser or any person the purchaser, either deliberately or undeliberately, gives access to the KRABAT product.
 7. This WARRANTY does not apply in so far that the KRABAT product is supplemented with or there are changed parts of the KRABAT product with parts not manufactured by KRABAT or with parts manufactured or provided by others and the use thereof is of not authorized in writing by KRABAT.
 8. KRABAT shall only be liable for defects which appear under conditions of operation or use provided for in the relevant user manual following the KRABAT product.
 9. KRABAT shall not be liable for defects which are caused by faulty maintenance, incorrect adjustments or faulty repair by any other person than KRABAT or representative authorized by KRABAT, or any alterations to the KRABAT product carried out without the prior written consent from KRABAT.
 10. This WARRANTY does not cover normal wear and tear.
 11. KRABAT shall not under any circumstances be liable for defects in any part of a KRABAT product for more than two (2) years from delivery.
 12. Save as set out above under this WARRANTY, KRABAT, as well as its authorized representatives, shall not be liable for any defects of the KRABAT product. This applies to any loss the defect may cause including loss of production, loss of profit and other indirect loss.



Hepro AS, avd. Krabat
Ravnsborgveien 56
1395 Hvalstad
Norway
www.krabat.no