

ROBUSTNESS

MODULARITY

CUSTOMIZATION

MOVILIDAD

MOBILITY

**ORT
HOS**

inclusive solutions
MOBILITY

HISTORIA HISTORY



ORTHOS XXI es un fabricante europeo, ubicado en Portugal, perteneciente al universo del material ortopédico y hospitalario. Creada en 2007, ORTHOS XXI sucede a ORTOMAIA, cuya actividad empezó en el año 1985. A lo largo de su trayecto de más de 30 años, ORTHOS XXI ha crecido y se ha consolidado, haciéndose una empresa reconocida y respetada, convirtiéndose incluso en un punto de referencia para muchos. De cara al futuro, hemos inaugurado recientemente un nuevo pabellón, duplicando así las instalaciones productivas.

ORTHOS XXI añade a su condición de fabricante europeo con un amplio catálogo propio, la distribución de los productos de reputadas empresas nacionales e internacionales. Pretendemos así consolidar nuestra posición de one stop shop de cercanía, explotando en simultáneo la vertiente de las necesidades especiales.



ORTHOS XXI participa regularmente en actividades internacionales de promoción y comercio, en Ferias y Congresos en el sector de la Salud, así como en misiones empresariales en varios países de Europa y en los Continentes Americano y Africano.

ORTHOS XXI is an European manufacturer located in Portugal, belonging to the universe of orthopedic and hospital materials. Founded in 2007, ORTHOS XXI succeeds ORTOMAIA, which activity began in 1985. Through these more than 30 years, ORTHOS XXI has grown and consolidated, converting itself into a recognised and respected company, a reference for many, even. Towards the future, we have recently inaugurated a new pavillion thereby doubling our production facilities.

ORTHOS XXI adds to its condition as an European manufacturer of an ever growing range of products, the distribution of products from reputed national and international companies, through agreements with them. We aim at consolidating our position as a vicinity one stop shop, simultaneously exploiting the special needs' aspect.

ORTHOS XXI regularly participates in international promotion and trade activities, in Exhibitions and

VALORES VALUES

Nos mueve la convicción de que, con nuestra labor, contribuimos diariamente para la mejora de la calidad de vida y para la satisfacción de las necesidades de los usuarios de nuestros productos y servicios. Priorizamos una actitud de trabajo en equipo, flexibilidad y mejora continua. Consideramos fundamental una constante inversión en innovación y desarrollo de los productos, contando actualmente con un equipo dedicado exclusivamente a esta finalidad.

Estos valores soportan la presentación, en este nuevo catálogo, de algunas de las novedades desarrolladas más recientemente y, a la par, dar respuesta a las necesidades personalizadas de los usuarios.

We are moved by the belief that, through our work, with our products and services, we daily contribute towards the improvement of end users' life quality and the satisfaction of their needs. We value a team work, flexibility and continuous improvement attitude. We believe it is vital to have a continuous investment in innovation and development of our products, thereby currently having a dedicated team for that purpose.

These values enable us to present, in this catalogue, some of the latest developments and, in parallel, to provide customised solutions to the end users' needs.

CALIDAD QUALITY

La calidad de los productos de ORTHOS XXI puede ser confirmada en los mejores hospitales e instituciones, donde nos han elegido. La mayoría de nuestros productos son dispositivos médicos de clase I y ostentan el marcado CE, según las Directivas Comunitarias 93/42/CEE y 2007/47/CE y están registrados en la Autoridad competente, Infarmed. Son testados por entidades acreditadas e independientes, como el IBV (Instituto de Biomecánica de Valencia, en España). La empresa está también certificada según la norma EN ISO 9001.

El valor y la cualificación de los recursos humanos a través de la implementación de actividades de entrenamiento y actualización en distintas áreas han sido fuertes apuestas de nuestra empresa. ORTHOS XXI tiene como principal preocupación la mejora continua de los procesos productivos y de los servicios, así como la mejora de la calidad de sus productos, lo que nos permite satisfacer cada vez mejor las necesidades y exigencias de clientes y usuarios.

The quality of ORTHOS XXI's products can be confirmed in the best hospitals and institutions, where they have been preferred. Most of them are Class I Medical Devices, CE marked in accordance with European Directives 93/42/CEE and 2007/47/CE and registered in the competent Authority, to Infarmed. Many are tested by well renowned and independent entities, namely IBV (Instituto de Biomecánica de Valencia, in Spain). The company is also certified in accordance to the EN ISO 9001 Standards.

The qualification of ORTHOS XXI's human resources, through the implementation of training in various areas, has been a strong stake. ORTHOS XXI's main concerns are to continuously improve its productive processes and services as well as the quality of its products, so as to better satisfy our costumers and end user's needs and demands.

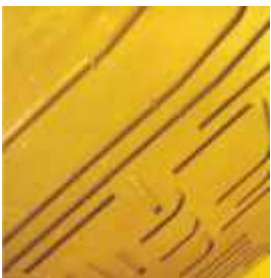



SILLAS MANUALES ACERO
MANUAL STEEL WHEELCHAIRS

CELTA COMPACT 3



51 CD C3 4 NO 43 NM

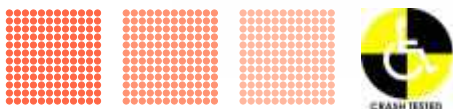

CELTA COMPACT 3 CELTA COMPACT 3 TRANSIT 51 CD C3 4 NO/AE 40/43/46 EM/NM/AM

Ruedas delanteras - macizas Front wheels - solid	Ø200mm
Ruedas traseras-macizas Back wheels - solid	Ø600mm/Ø300mm
Llantas traseras Rear rims	nylon
Color - estructura Colour - structure	azul blue
Color - tapicería Colour - upholstery	negro black
Tallas disponibles Available sizes	40/43/46cm
Peso sin comp. desmontables Weight without dsmountable components	12,2kg/11kg
Peso total Total weight	14,6kg/13,4kg
Peso máximo de usuario Maximum user weight	150kg

CELTA COMPACT 3, silla en acero, resistente y funcional. Estructura en azul con tapizados negros. Reposabrazos desmontables y reversibles para más libertad de movimientos. Reposapiés regulables en altura y extraíbles. Tubos Ø25mm y cruceña triple para maior robustez. Ruedas traseras macizas con llantas en nylon y Ø600mm o Ø300mm (transit).

CELTA COMPACT 3, a resistant and functional wheelchair made of steel. Structure in blue with black upholstery. Removable and reversible arm rests so the user can have more freedom in movement. Removable and height adjustable foot rests. Ø25mm tubes and triple cross bar for enhanced robustness. Solid back wheels with nylon rims and Ø600mm or Ø300mm (transit).



Cruceta triple
Triple cross bar



Reposabrazos extraíbles
Removable armrest



51 CD C3 4 AE 43 AM



CELTA COMPACT 3 40	61	40	32	92	72	51	41	101	83	42	150	14,6
CELTA COMPACT 3 43	64	43	32	92	72	51	41	101	83	42	150	14,8
CELTA COMPACT 3 46	67	46	32	92	72	51	41	101	83	42	150	15,0
CELTA COMPACT 3 TRANSIT 40	56	40	31	92	72	49	41	94	76	42	150	13,4
CELTA COMPACT 3 TRANSIT 43	59	43	31	92	72	49	41	94	76	42	150	13,6
CELTA COMPACT 3 TRANSIT 46	62	46	31	92	72	49	41	94	76	42	150	13,8



51 CD CE 2 NO 40 ND



51 CD CE 2 AE 40 AD

CELTA, la silla con un diseño atractivo y flexible, estructura ligera, moderna y robusta. Tubos de Ø25mm y cruceta triple para una mayor robustez. Reposabrazos desmontables con un diseño atractivo y flexible. Reposapiés desmontables y regulables en altura. Rueda trasera de Ø600mm con quick release de serie (excepto talla 50) para un fácil transporte. **Ver accesorios y opciones.**

CELTA, wheelchair with attractive and flexible design, modern and robust structure. Ø25mm tubes and triple cross bar for extra robustness. Removable armrest with an attractive and flexible design. Removable and height adjustable footrest. Ø600mm rear wheels with quick release (except size 50) for easy transport. **See accessories and options.**

CELTA / CELTA TRANSIT

51 CD CE 2/4/6 NO 37/40/43/46/50 NM/ND/ED/EM
51 CD CE 2/4/6 AE 37/40/43/46/50 AD/AM

Ruedas delanteras -macizas Front wheels - solid	Ø200mm
Ruedas traseras Back wheels	Ø600mm/ Ø300mm
Llantas traseras Rear rims	nylon / rayadas nylon / spokes
Color - estructura Colour - structure	gris metalizado metallic grey
Color - tapicería Colour - upholstery	negro black
Tallas disponibles Available sizes	37/40/43/46/50cm
Peso sin componentes desmontables Weight without dismountable components	8,6kg
Peso total Total weight	15,9kg / 14,2kg
Peso máximo de usuario Maximum user weight	150kg

Plegable Foldable



Quick release



Cruceta triple Triple cross bar



CELTA 37
CELTA 40
CELTA 43
CELTA 46
CELTA 50
CELTA TRANSIT 37
CELTA TRANSIT 40
CELTA TRANSIT 43
CELTA TRANSIT 46
CELTA TRANSIT 50

57	37	28	93	73	51	41	100	78	42	150
60	40	28	93	73	51	41	100	78	42	150
63	43	28	93	73	51	41	100	78	42	150
66	46	28	93	73	51	41	100	78	42	150
69	50	28	93	73	51	41	100	78	42	150
54	37	30	93	73	51	41	88	66	42	150
55	40	30	93	73	51	41	88	66	42	150
60	43	30	93	73	51	41	88	66	42	150
63	46	30	93	73	51	41	88	66	42	150
66	50	30	93	73	51	41	88	66	42	150

CELTA EVOLUTION



CELTA EVOLUTION

51 CD CV 2 NO/AE 40/43/46 EM/AM

Ruedas delanteras - macizas Front wheels - solid	Ø200mm
Ruedas traseras Back wheels	Ø600mm
Llantas traseras Rear rims	nylon / rayadas nylon / spokes
Color - estructura Colour - structure	rojo red
Color - tapicería Colour - upholstery	negro black
Tallas disponibles Available sizes	40/43/46cm
Peso sin componentes desmontables Weight without desmountable components	8,6kg
Peso total Total weight	16,5kg
Peso máximo de usuario	150kg

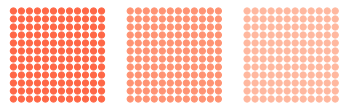

CELTA EVOLUTION es una silla de ruedas manual de acero, con diseño atractivo, funcionalidad y robustez. Indicada para usuarios con disminución general de la movilidad, es una silla robusta y duradera, práctica de usar en el día a día. Además, permite diversas configuraciones y la inclusión de accesorios para un mejor ajuste a la condición del usuario, a lo largo del tiempo. Con estructura reforzada con tubos de 25mm de diámetro y cruceta triple para proporcionar mayor resistencia. Reposabrazos abatibles para facilitar la transferencia. Reposapiés desmontables y regulables en altura con apertura bilateral. Tapicería resistente al fuego de acuerdo con la norma EN 1102: 1995. Ruedas traseras de 600mm con aro de aluminio, hinchables o macizas. Llantas de nylon o rayadas. Ruedas delanteras 200x30mm macizas (opción: ruedas hinchables 200x50mm). Fácil de transportar, es de encartar y posee quick release de la rueda trasera (excepción: talla 50 no tiene quick release). Ancho de asiento: 370, 400, 430, 460mm. Peso máximo de usuario: 150Kg.

CELTA EVOLUTION is a manual steel wheelchair with attractive design, functionality and robustness. Indicated for users with general mobility impairment, it is a sturdy and durable chair, practical to use on a day-to-day basis. In addition, it allows for various configurations and the inclusion of accessories to better adjust to the condition of the user, over time. Reinforced structure with tubes of 25mm in diameter and triple cross for greater resistance. Folding arms support for easy transfer. Height-adjustable footrests with bilateral opening. Fire resistant upholstery in accordance with EN 1102: 1995. Rear wheels 600mm with aluminum rim, pneumatic or solid. Nylon or spoke rims. Solid 200x30mm front wheels (option: pneumatic wheels 200x50mm). Easy to carry, easy to attach and has quick release of rear wheel (exception: size 50 has no quick release). Seat width: 370, 400, 430, 460mm. Maximum user weight: 150 kg.

CELTA 37	59	37	28	92	71.5	51	43.5	105	81	42	150	16.5
CELTA 40	62	40	28	92	71.5	51	43.5	105	81	42	150	16.5
CELTA 43	65	43	28	92	71.5	51	43.5	105	81	42	150	16.5
CELTA 46	68	46	28	92	71.5	51	43.5	105	81	42	150	16.5
CELTA 50	72	50	28	92	71.5	51	43.5	105	81	42	150	16.5

CELTA CAMA CELTA BED

CELTA CAMA/BED CELTA CAMA/BED TRANSIT	
51 CD CE 2 CM 37/40/43/46/50 ED/EM	
51 CD CE 2 CM AE 37/40/43/46/50 AM	
Ruedas delanteras - macizas Front wheels - solid	Ø200mm
R traseras - hinchable o macizas Back wheels - solid or pneumatic	Ø600mm/Ø300mm
Llantas traseras Rear rims	rayadas spokes
Color - estructura Colour - structure	gris metalizado metallic grey
Color - tapicería Colour - upholstery	negro black
Tallas disponibles Available sizes	37/40/43/46/50cm
Peso sin componentes desmontables Weight without desmountable components	20kg
Peso total Total weight	23,8kg / 25,3kg
Peso máximo de usuario Maximum user weight	125kg



51 CD CE 2 CM 40 ED

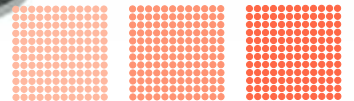

Adecuadamente reforzada para proporcionar al usuario la comodidad de una silla con función de cama y inclinación mecánica por suaves y seguros pistones. Tapicería en nylon. Reposabrazos desmontables y reversibles. La inclinación del respaldo de 93° a 150° permite al usuario una posición cómoda, completándolo con la elevación de los reposapiés al mismo nivel del asiento. **Ver accesorios y opciones.**

Suitably reinforced to provide the user the comfort of a chair with bed function with smooth and safe pistons for manual recline. Nylon upholstery. Armrests removable and reversible. The ability to tilt the backrest from 93° to 150° allows the user to put up in full position, comfortably, supplementing it with the elevation of the footrests at the same level of the seat. **See accessories and options.**



CELTA CAMA/BED 37	57	37	110-125	73	51	58 (+15)	125-150	90	44	93°-150°	125	23,8
CELTA CAMA/BED 40	60	40	110-125	73	51	58 (+15)	125-150	90	44	93°-150°	125	24,0
CELTA CAMA/BED 43	63	43	110-125	73	51	58 (+15)	125-150	90	44	93°-150°	125	24,2
CELTA CAMA/BED 46	66	46	110-125	73	51	58 (+15)	125-150	90	44	93°-150°	125	24,4
CELTA CAMA/BED 50	69	50	110-125	73	51	58 (+15)	125-150	90	44	93°-150°	125	24,6
CELTA CAMA/BED TRANSIT 37	54	37	110-125	73	51	58 (+15)	125-150	90	44	93°-150°	125	25,3
CELTA CAMA/BED TRANSIT 40	57	40	110-125	73	51	58 (+15)	125-150	90	44	93°-150°	125	25,5
CELTA CAMA/BED TRANSIT 43	60	43	110-125	73	51	58 (+15)	125-150	90	44	93°-150°	125	25,7
CELTA CAMA/BED TRANSIT 46	63	46	110-125	73	51	58 (+15)	125-150	90	44	93°-150°	125	25,9
CELTA CAMA/BED TRANSIT 50	66	50	110-125	73	51	58 (+15)	125-150	90	44	93°-150°	125	26,1

CELTA MANDO CELTA COMMAND



51 CD CE 2 CO 40 ED D

Con las características estructurales de la CELTA, esta es la solución para conducir solo con una mano. Rueda con doble mando para fácil tracción y conducción con solo una mano. Adecuado para usuarios con hemiplejía.

With the structural characteristics of CELTA, this is the solution for driving with only one hand. Dual wheel for easy pulling and driving single handed. Suitable for users with hemiplegia.

REGANAR INDEPENDENCIA
REGAIN INDEPENDENCE

CELTA MANDO / COMMAND 51 CD CE 2 CO 37/40/43/46/50 ED D/E

Rueda delantera- maciza Front wheel - solid	Ø200mm
Rueda trasera- hinchable Rear wheel - pneumatic	Ø600mm
Llantas traseras Rear rims	rayadas spokes
Color - estructura Colour - structure	gris metalizado metallic grey
Peso sin componentes desmontables Weight without detachable components	15,1kg
Peso total Total weight	17,5kg
Peso máximo del usuario Maximum user weight	125kg



CELTA MANDO/COMMAND 37
CELTA MANDO/COMMAND 40
CELTA MANDO/COMMAND 43
CELTA MANDO/COMMAND 46
CELTA MANDO/COMMAND 50

57	37	28	92	73	45	43	101	78	42	125	17,5
60	40	28	92	73	45	43	101	78	42	125	17,7
63	43	28	92	73	45	43	101	78	42	125	17,9
66	46	28	92	73	45	43	101	78	42	125	18,1
69	50	28	92	73	45	43	101	78	42	125	18,3

CELTA EJE RETRASADO CELTA RECOIL

EQUILÍBRAR CARGAS
LOAD BALANCING



51 CD CE 2 ER 40 ED

Con la CELTA EJE RETRASADO, el centro de gravedad está retrasado para permitir el adecuado equilibrio, por ejemplo para un amputado. Dos puntos posibles de encaje del eje retrasado (10 y 15cm) desde el eje normal. Ver accesorios y opciones.

With CELTA RECOIL, the center of gravity is behind to allow proper balance, for example for an amputee. Two possible points of recoil (10 and 15cm) from the normal axis. See accessories and options.

CELTA EJE RETRASADO / RECOIL 51 CD CE 2 ER 37/40/43/46/50 ED

Rueda delantera- maciza Front wheel - solid	Ø200mm
Rueda trasera - hinchable o maciza Rear wheel - solid or pneumatic	Ø600mm
Llantas traseras Rear rims	rayadas spokes
Color - estructura Colour - structure	gris metalizado metallic grey
Peso sin componentes desmontables Weight without detachable components	15,5kg
Peso total Total weight	17,5kg
Peso máximo del usuario Maximum user weight	150kg



CELTA EJE RETRASADO/RECOIL 37
CELTA EJE RETRASADO/RECOIL 40
CELTA EJE RETRASADO/RECOIL 43
CELTA EJE RETRASADO/RECOIL 46
CELTA EJE RETRASADO/RECOIL 50

59	37	28	92	72	51	40	110/115	88/93	42	150	17,5
62	40	28	92	72	51	40	110/115	88/93	42	150	17,7
65	43	28	92	72	51	40	110/115	88/93	42	150	17,9
68	46	28	92	72	51	40	110/115	88/93	42	150	18,1
71	50	28	92	72	51	40	110/115	88/93	42	150	18,3

PENINSULAR

LA SOLUCIÓN PARA TALLAS GRANDES
THE SOLUTION FOR LARGE SIZES



51 CD PN 2 NO 54 EM

PENINSULAR / PENINSULAR TRANSIT 51 CD PN 2 NO/AE 54/58 EM/AM

Ruedas delanteras - macizas Front wheels - solid	Ø200mm
Ruedas traseras- hinchable o macizas Back wheels - neumaticas or solid	Ø600mm/Ø300mm
Llantas traseras Rear rims	rayadas spokes
Color - estructura Colour - structure	gris metalizado metallic grey
Color - tapicería Colour - upholstery	negro black
Tallas disponibles Available sizes	54/58cm
Peso sin componentes desmontables Weight without desmountable components	17kg
Peso total Total weight	20kg
Peso máximo de usuario Maximum user weight	160kg

Porque ni todos tenemos la misma talla!!! La PENINSULAR se adecua a si, por su configuración. Con la cruceta triple y tela reforzada para una mayor robustez. Permite la colocación de toda la gama de accesorios CELTA lo que es una gran silla adaptable, porque para tamaños grandes, grandes remedios. Con capacidad hasta 160kg. Hacemos medidas personalizadas, según la talla y peso del utilizador. Consulte también nuestra gama bariátrica (hasta 250kg). **Ver accesorios y opciones.**

Because not all have the same size! PENINSULAR offers the user an adaptable wheelchair to your size and even more adaptable to your needs. With reinforced triple cross bar and upholstery for robustness. Allows the placement of all accessories CELTA range making it a great adaptable chair, because for large sizes, large solutions. With capacity up to 160kg. We manufacture customized according to the size and weight of the user's size and weight. Check also our bariatric line (up to 250kg). **See accessories and options.**

Reposabrazos destacables Detachable armrests



Plegable Foldable



Cruceta triple reforzada Reinforced triple cross bar



Freno de estacionamiento Parking brake



Reposapiés más ancho Wider foot rests



PENINSULAR 54
PENINSULAR 58
PENINSULAR TRANSIT 54
PENINSULAR TRANSIT 58

74	54	28	92	72	51	41	100	78	42	160
78	58	28	92	72	51	41	100	78	42	160
71	54	30	92	72	51	41	94	72	42	160
75	58	30	92	72	51	41	94	72	42	160

LUSA

EL CONFORT DE UNA SILLA COMFORT IN A CHAIR

Ruedas de transfer Transfer wheels



Almohada en viscoelástico Memory foam pad

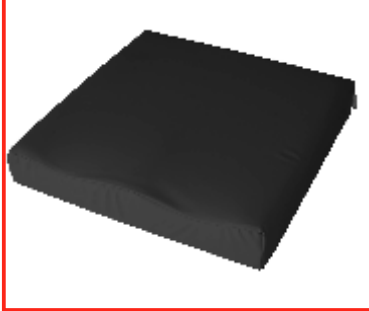

51CD LU W NO 40 EP

LUSA permite la extracción rápida de las ruedas traseras, facilitando su transporte; las ruedas de transfer la hacen muy adecuada para espacios angostos e interiores. Porque se merece sentirse bien donde quiera que esté, incluye un asiento en viscoelástico anatómico. **Ver accesorios y opciones.**

LUSA has quick release in the rear wheels, easing its transport; the transfer wheels are very suitable for small indoor spaces. Because you deserve to feel good wherever you are, it includes an anatomical memory foam seat. **See accessories and options.**

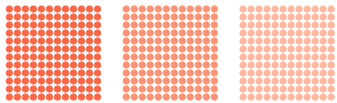

LUSA 51 CD LU W NO 40/43/46 EP

Ruedas delanteras - macizas Front wheels - solid	Ø200mm
Ruedas traseras hinchable Back wheels neumatic	Ø600mm
Rodeznos Casters	Ø75mm
Llantas traseras Rear rims	rayadas spokes
Color - estructura Colour - structure	gris metalizado metallic grey
Color - tapicería Colour - upholstery	negro black
Tallas disponibles Available sizes	40/43/46cm
Peso sin componentes desmontables Weight without desmountable components	10kg
Peso total Total weigh	17,5kg
Peso máximo de usuario Maximum user weight	150kg

Reposabrazos desmontables Removable armrests



Plegable Foldable



Cruceta triple Triple cross bar



Freno de estacionamiento Parking brake



Bolso Bag



LUSA 40	51 - 59	40	29	92	72	51	42	94 / 100	78	42	150	17,5
LUSA 43	54 - 62	43	29	92	72	51	42	94 / 100	78	42	150	17,7
LUSA 46	57 - 65	46	29	92	72	51	42	94 / 100	78	42	150	17,9



51 CD IB 2 NO 39 NP

IBERA fue diseñada para ser adaptable a las necesidades de cada persona, permitiendo al usuario utilizar una silla sencilla y tan completa como sea necesario. Tubos de Ø25mm y cruceta triple para una mayor robustez. Las fajas regulables en tensión en el respaldo y el sistema de amortiguación en la estructura ofrecen un confort añadido. Ruedas delanteras macizas de Ø200mm (opción: hinchables) y ruedas traseras macizas de Ø600mm con eje de extracción rápida para facilitar el transporte.

IBERA was designed to be adaptable to the needs of each individual, allowing the user to use a simple wheelchair as complete as necessary. Ø25mm tubes and triple cross bar for extra robustness. The tension regulating bands at the back and the suspension system in the structure provide additional comfort. Ø200mm solid front wheels (Option: pneumatic) and Ø600mm solid rear wheels with quick release for easy transport.



51 CD IB 2 AE 39 AP

Sencilla, ligera y versátil. Una silla que combina la versatilidad de la gama de Ibera optimizada con ruedas Ø300mm, para propulsión con cuidador.

Simple, lightweight, and versatile. A wheelchair that combines the versatility of Ibera range to optimize Ø300mm wheels, driven by the attendant.

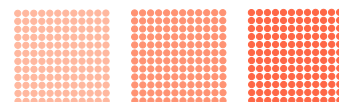

IBERA / IBERA TRANSIT

51 CD IB 2 NO 39/42/45 ED/EM/EP/ND/NM/NP
51 CD IB 2 AE 39/42/45 AP

Ruedas delanteras - macizas Front wheels - solid	Ø200mm
Ruedas traseras Back wheels	Ø600mm / Ø300mm
Llantas traseras Rear rims	nylon / rayadas nylon / spokes
Color - estructura Colour - structure	blanco white
Color - tapicería Colour - upholstery	negro black
Tallas disponibles Available sizes	39/42/45cm
Peso sin componentes desmontables Weight without dismountable components	10,2kg / 11,8kg
Peso total Total weight	17,2kg / 15,4kg
Peso máximo de usuario Maximum user weight	150kg



Bolso
Bag



Respaldo reg.en tensión
Tension adjustable back



Sistema de suspensión
Suspension system

IBERA 39
IBERA 42
IBERA 45
IBERA TRANSIT 39
IBERA TRANSIT 42
IBERA TRANSIT 45

60	39	31	92	72	52	39	102	78	42	150	17,2
63	42	31	92	72	52	39	102	78	42	150	17,4
65	45	31	92	72	52	39	102	78	42	150	17,6
57	39	33	92	72	52	39	96	72	42	150	15,4
60	42	33	92	72	52	39	96	72	42	150	15,6
62	45	33	92	72	52	39	96	72	42	150	15,8

Accesorios & Opciones | Accessories & Options

Verifique el modelo específico | Check the specific model

Soporte de cabeza
Head rest



Soporte de cabeza en U
U shape head rest



Soporte de cabeza envolvente
Contoured head rest



Esirador
Back stretcher



Respaldo partido
Folding back



Respaldo reclinable (manual)
Reclining back (manual)



Respaldo reclinable (pistones)
Reclining back (gas piston)



Respaldo reg.tensión parcial
Adjust. partial tensioning back



Respaldo rígido
Rigid back



Almohada comfort back sop. lat. en PU
PU cover lateral support comfort back



Almohada comfort back sop. lat. en 3D
3D cover lateral support comfort back



Respaldo 3D reg tensión total
Adjust. total tensioning back 3D cover



Almohada comfort back sop. lom.
Lumbar support comfort back



Almohada soft back sop. lom.
Lumbar support soft back



Almohada comfort back sop. hombros
Shoulder support comfort back



Extensión comfort back 100mm
Comfort back 100mm extension



para placa rígida extensible
for solid back plate extension

Extensión comfort back 200mm
Comfort back 200mm extension



para placa rígida extensible
for solid back plate extension

Apoya brazo largo
Long arm rests



Apoyabrazos reg. en altura
Height adjust. armrests



Apoyabrazos sencillas abatibles
Simple folding armrests



Asiento rígido
Rigid seat



Almohada PU soft seat 70mm
Soft seat 70mm cushion PU cover



Almohada 3D soft seat 70mm
Soft seat 70mm cushion 3D cover



Apoyabrazos completos abatibles
complete folding armrests



Almohada PU comfort seat 80mm
Comfort seat 80mm cushion PU cover



Almohada 3D comfort seat 80mm
Comfort seat 80mm cushion 3D cover



Asiento sanitario anatómico
Anatomic sanitary seat



Asiento sanitario ABS
ABS sanitary seat



Accesorios & Opciones | Accessories & Options

Verifique el modelo específico | Check the specific model

Soporte de gemelos
Leg rest



Reposapiés elevables
Elevating leg rests



Reposapiés de aluminio
Aluminum footrests



Reposapiés único
Onepiece footrest



Soporte de tronco
Trunk support



Cinturón de seguridad
Safety belt



Soporte de amputado
Amputee support



Abductor
Abductor



Soporte suero
Serum support



Soporte oxígeno
Oxygen support



Tablero acrílico
Acrylic board



Tablero madera
Wood board



Ruedas anti-vuelco
Anti-tipping wheels



Kit transfer
Transfer kit



Aro motor con 8 pitones
Rim with 8 supports



Ruedas delantera hinchable
Pneumatic front wheels



Rueda tras 300mm hinchable
300mm pneumatic rear wheel



Rueda tras 300mm maciza
300mm solid rear wheel



Ruedas delantera maciza
Solid front wheels



Rueda tras 600mm radios hinch
600mm rear pneum spokes wheel



Rueda tras 600mm nylon hinch.
600mm rear pneum. nylon wheel



Rueda tras 600mm nylon maciza
600mm rear solid nylon wheel



Freno de cuidador
Attendant's brake



Impermeable
Rain coat



SILLAS MANUALES ALUMINIO
MANUAL ALUMINUM WHEELCHAIRS



LATINA COMPACT



OPCIONES DE COLORES:
COLOUR OPTIONS:



51 CD LC 2 NO 40 EM



LATINA COMPACT/LATINA COMPACT TRANSIT
51 CD LC 9/3 NO 40/43/46 EM
51 CD LC 9/3 AE 40/43/46 AM

Ruedas delanteras - macizas Front wheels - solid	Ø200mm
Ruedas traseras Back wheels	Ø600mm / Ø300mm
Llantas traseras Rear rims	rayadas spokes
Color - estructura Colour - structure	blanco o gris metalizado white or metallic grey
Color - tapicería Colour - upholstery	negro black
Tallas disponibles Available sizes	40/43/46cm
Peso sin componentes desmontables Weight without dismountable components	7,4kg
Peso total Total weight	12kg / 14kg
Peso máximo de usuario Maximum user weight	125kg

LATINA COMPACT, silla en aluminio con cruceta triple, compacta y ligera. Estructura blanca o gris y tapicería en negro. Opción colores de tapizado: berenjena, pistacho, verde oscuro y crema (coste adic.). Reposabrazos abatibles y reposapiés ajustables en altura y destacables. En 3 tallas, con ruedas Ø600mm con radios con sistema de eje de extracción rápida y Ø300mm (transit).

LATINA COMPACT, a compact and lightweight aluminium wheelchair with triple cross bar. White or grey structure and black upholstery. Upholstery colour options: lilac, pistachio, dark green and cream (additional cost). Folding armrest; detachable and height adjustable foot rest. In 3 sizes, with quick release Ø600mm (spokes rims) and Ø300mm (transit) wheels.

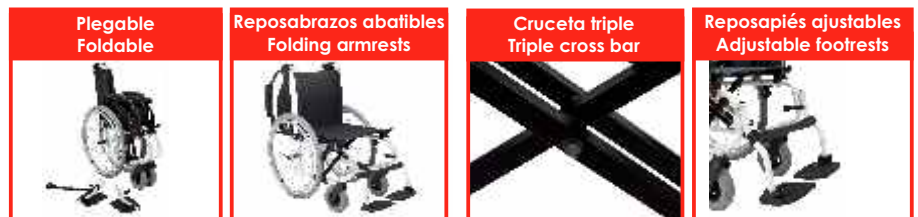

LATINA COMPACT 40	58	40	29	92	72	51	41	106	83	42	125	12
LATINA COMPACT 43	60	43	29	92	72	51	41	106	83	42	125	12,1
LATINA COMPACT 46	63	46	29	92	72	51	41	106	83	42	125	12,2
LATINA COMPACT TRANSIT 40	58	40	29	92	72	51	41	97	76	42	125	14
LATINA COMPACT TRANSIT 43	60	43	29	92	72	51	41	97	76	42	125	14,1
LATINA COMPACT TRANSIT 46	63	46	29	92	72	51	41	97	76	42	125	14,2

LATINA



OPCIONES DE COLORES: COLOUR OPTIONS:



51 CD LA 2 AE 40 AM



51 CD LA 2 NO 40 EM

LATINA / LATINA TRANSIT

51 CD LA NO 9/3 37/40/43/46 ED/EM
51 CD LA 9/3 AE 37/40/43/46 AD/AM

Ruedas delanteras - macizas Front wheels - solid	Ø200mm
Ruedas traseras Back wheels	Ø600mm / Ø300mm
Llantas traseras Rear rims	rayadas spokes
Color - estructura Colour - structure	blanco o gris metalizado white or metallic grey
Color - tapicería Colour - upholstery	negro o opciones black or options
Tallas disponibles Available sizes	37/40/43/46/50cm
Peso sin componentes desmontables Weight without desmountable components	7,6kg/13,1kg
Peso total Total weight	12,4kg/13,9kg
Peso máximo de usuario Maximum user weight	125kg

LATINA, silla ligera en aluminio con cruceta tripla y diseño llamativo. Estructura blanca y tapicería en negro. Reposabrazos abatibles (opción: destacables) y reposapiés ajustables en altura y extraíbles. En 5 tallas, con ruedas Ø600mm (rayadas) con sistema de extracción rápida o Ø300mm (transit). Opción colores de tapizado: berenjena, pistacho, verde oscuro y crema. **Ver accesorios y opciones.**

Freno de aluminio Parking brake



LATINA, a lightweight aluminium wheelchair with triple cross bar and an attractive design. White structure and black upholstery. Folding armrest (option: removable) and detachable and height adjustable foot rest, detachable. In 5 sizes, with Ø600mm (spokes rims) or Ø300mm (transit) wheels. Upholstery colour options: lilac, pistachio, dark green and cream. **See accessories and options.**

Cruceta tripla Triple cross bar



LATINA 37	57	37	30	93	72	51	41	100	77	42	125	12,4
LATINA 40	60	40	30	93	72	51	41	100	77	42	125	12,5
LATINA 43	63	43	30	93	72	51	41	100	77	42	125	12,6
LATINA 46	66	46	30	93	72	51	41	100	77	42	125	12,7
LATINA 50	70	50	30	93	72	51	41	100	77	42	125	12,8
LATINA TRANSIT 37	54	37	30	93	72	51	41	96	70	42	125	13,9
LATINA TRANSIT 40	57	40	30	93	72	51	41	96	70	42	125	14,0
LATINA TRANSIT 43	60	43	30	93	72	51	41	96	70	42	125	14,1
LATINA TRANSIT 46	63	46	30	93	72	51	41	96	70	42	125	14,2
LATINA TRANSIT 50	67	50	30	93	72	51	41	96	70	42	125	14,3



51 CD LL 3 E4 40

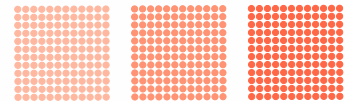

La silla EXTRALIGHT, en aluminio de alta resistencia es plegable y de fácil transporte porque tiene ruedas traseras de extracción rápida. El brillo de su estructura barnizada le confiere ligereza teniendo la posibilidad de cambiar el eje de carga para un aumento del rendimiento de la silla. La concepción del chasis con cruceta doble garantiza la robustez y la seguridad que se desea en una silla de aluminio.

También disponible en las tallas 50, 52 y 55.

Ver accesorios y opciones.

EXTRALIGHT 17.68N

51 CD LL 3/4 E4 40/44/48

Rueda delantera maciza	Ø180mm
Rueda trasera hinchable	Ø600mm
Color estructura	gris o azul
Color tapicería	negro
Peso máximo del usuario	120kg
Peso total	15kg

Disponible en España



EXTRALIGHT 36	54	36	27	75-80	65	44-55	34-42	85-93	72-80	40	120	15-16
EXTRALIGHT 40	60	40	27	93-101	69-75	46-52	41-49	104-112	77-85	40	120	15-16
EXTRALIGHT 44	64	44	27	93-101	69-75	46-52	41-49	104-112	77-85	40	120	15-16
EXTRALIGHT 48	68	48	27	93-101	69-75	46-52	41-49	104-112	77-85	40	120	15-16

LATINA ADVANCE



51 CD LD 2 NO 40 ED



LATINA ADVANCE LATINA ADVANCE TRANSIT 51 CD LD 2 NO/AE 37/40/43/46 ED

Ruedas delanteras - macizas Front wheels - solid	Ø200mm
Ruedas traseras - macizas Back wheels - solid	Ø600mm / Ø300mm
Llantas traseras Rear rims	rayadas spokes
Color - estructura Colour - structure	blanco white
Color - tapicería Colour - upholstery	negro black
Tallas disponibles Available sizes	37/40/43/46/50cm
Peso sin componentes desmontables Weight without dismountable components	9,2kg
Peso total Total weight	16,2kg
Peso máximo de usuario Maximum user weight	125kg

LATINA ADVANCE, silla de aluminio ajustable en altura y profundidad, con tubos de Ø25mm y cruceta triple para una mayor robustez. Estructura blanca y tapicería en negro. Opciones de colores: berenjena, pistacho, crema y verde oscuro. Reposabrazos ajustables en altura y profundidad. Reposapiés extraíbles y con apertura bilateral. Respaldo partido (opción) reduciendo el tamaño total de la silla cuando se pliega facilitando su transporte y almacenamiento. Asiento ajustable en profundidad. Respaldo ajustable en altura y con fajas tensoras lumbares. 5 tallas disponibles, con ruedas de radios (Ø600mm) o Ø300mm con kit (opción). **Ver accesorios y opciones.**

LATINA ADVANCE, height and depth adjustable aluminium wheelchair with Ø25mm tubes and triple crossbar for robustness. White structure and black upholstery. Colour options: lilac, pistachio, cream and dark green. Height and depth adjustable armrests. Removable footrests with bilateral opening. Height adjustable backrest with tensioning bands and depth adjustable seat. Folding backrest (option) reducing the overall size of the chair when folded for easy transport and storage. 5 sizes available with Ø600mm wheels (spoked) or Ø300mm with kit (option). **See accessories and options.**



LATINA ADVANCE 37	57	37	30	92	68-76	51	41	103	82	42	125
LATINA ADVANCE 40	60	40	30	92	68-76	51	41	103	82	42	125
LATINA ADVANCE 43	63	43	30	92	68-76	51	41	103	82	42	125
LATINA ADVANCE 46	66	46	30	92	68-76	51	41	103	82	42	125
LATINA ADVANCE 50	70	50	30	92	68-76	51	41	103	82	42	125
LATINA ADVANCE TRANSIT 37	54	37	30	92	68-76	51	41	96	75	42	125
LATINA ADVANCE TRANSIT 40	57	40	30	92	68-76	51	41	96	75	42	125
LATINA ADVANCE TRANSIT 43	60	43	30	92	68-76	51	41	96	75	42	125
LATINA ADVANCE TRANSIT 46	63	46	30	92	68-76	51	41	96	75	42	125
LATINA ADVANCE TRANSIT 50	67	50	30	92	68-76	51	41	96	75	42	125

ATIVA INVICTUS



OPCIONES DE COLORES: COLOUR OPTIONS:



51 CD AC 9 NO 40 ED

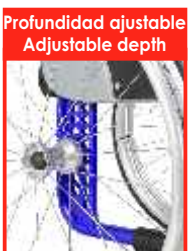

ATIVA INVICTUS, silla en aluminio Ø25mm muy ligera. Con cruceta triple, resistente y funcional. Estructura con altura y profundidad regulables. Cójin viscoelástico con tela de abeja. Respaldo regulable en altura y tensión, con viscoelástico recubierto con funda tela de abeja. Reposapiés independientes, regulables en altura. Salva ropa (opción: reposabrazos) Ruedas traseras hinchables con extracción rápida permite fácil almacenamiento y transporte.

Ver accesorios y opciones.

ATIVA INVICTUS, resistant and functional Ø25mm tubes and triple cross bar wheelchair made of aluminium. Structure with height and depth adjustments. Height and tension adjustable upholstery, with memory foam and 3D cover. Height adjustable independent foot rests. Pneumatic back wheels with quick release for easy storage and transport.

See accessories and options.

ATIVA INVICTUS 51 CD AC 4/6/9 NO 40/43/46 ED

Ruedas delanteras - macizas Front wheels - solid	Ø150mm
Ruedas traseras - macizas Back wheels - solid	Ø600mm
Llantas traseras Rear rims	rayadas spokes
Color - estructura Colour - structure	rojo, azul o blanco red, blue or white
Color - tapicería Colour - upholstery	negro black
Tallas disponibles Available sizes	40/43/46cm
Peso sin componentes desmontables Weight without dismountable components	9,6kg
Peso total Total weight	12,9kg
Peso máximo de usuario Maximum user weight	125kg



ATIVA INVICTUS 40	58	40	30	89-99	73	51	34-44	91	42-44	125	9,6
ATIVA INVICTUS 43	61	43	30	89-99	73	51	34-44	91	42-44	125	9,6
ATIVA INVICTUS 46	64	46	30	89-99	73	51	34-44	91	42-44	125	9,6

ACTIVA COMPACT



51 CD LL 4 CA 40

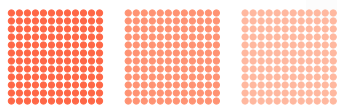

ACTIVA COMPACT 17.70N

51 CD LL 4/6 CA 38/40/44/48

Rueda delantera maciza	Ø120mm
Rueda trasera con QR	Ø600mm
Color estructura	rojo o azul
Color tapicería	negro
Peso máximo del usuario	120kg
Peso total	13kg

La silla EVOLUTION ACTIVA COMPACT tiene una reducción máxima de las dimensiones totales. Mantiene un asiento ajustable que pueda servir a usuarios de tallas medios/grandes siendo sensiblemente 20cm más compacta que una silla normal. Su estructura de cruceta doble garantiza toda la seguridad, durabilidad y robustez deseadas. Reposapiés único abatible. Permite cambiar el eje y la distribución de las cargas por medio de los fulcros en las ruedas grandes y en las ruedas pequeñas. Posee el respaldo acolchado, puños para el cuidador y ruedas traseras extraíbles. Permite la variación de la altura del respaldo así como el ajuste de la tensión del respaldo por las bandas tensoras. Permite la basculación del asiento hasta 10°. Con ruedas de extracción rápida garantiza un fácil transporte y almacenaje.

Posibilidad de colocar diversos accesorios.

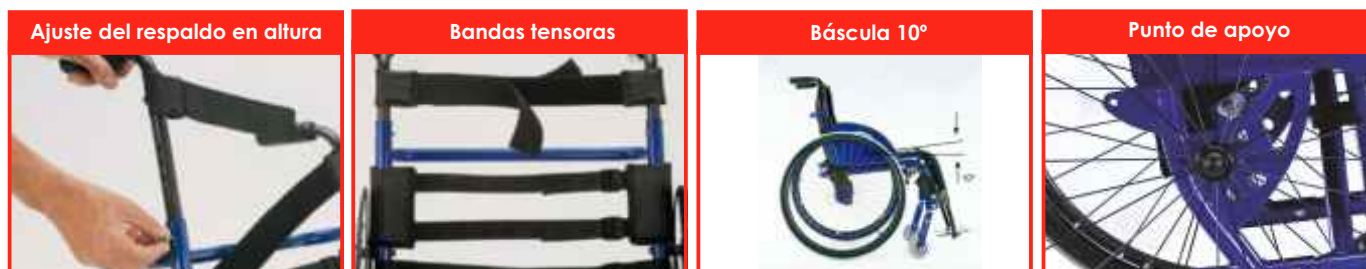

Disponible en España



ACTIVA COMPACT 36	54	36	34	75-80	60	44-50	34-42	74-80	44-52	36-44	100	12-13
ACTIVA COMPACT 38	58	38	34	79-87	70	46-52	34-42	83-91	44-52	44-52	120	12-13
ACTIVA COMPACT 40	60	40	34	79-87	70	46-52	34-42	83-91	44-52	44-52	120	12-13
ACTIVA COMPACT 44	64	44	34	79-87	70	46-52	34-42	83-91	44-52	44-52	120	12-13
ACTIVA COMPACT 48	68	48	34	79-87	70	46-52	34-42	83-91	44-52	44-52	120	12-13

ACTIVA 4LIFE



51 CD LL 4 AL 40

ACTIVA 4LIFE 12.70 51 CD LL 4 AL 38/40/44/48

Ruedas delanteras - macizas	Ø100mm
Ruedas traseras - hinchables	Ø600mm
Color de la estructura	rojo, azul o negro
Color - tapicería	negro
Peso máximo de usuario	120kg
Peso total	9,8kg



ACTIVA 4LIFE, silla compacta en aluminio plegable para facilitar el transporte. La estructura ligera y la conducción fácil, asociadas al bajo peso, hacen que esta silla sea indicada para usuarios activos, que mantengan un buen equilibrio de tronco, así como fuerza y movilidad de los miembros superiores, siendo así capaces de mover la silla de ruedas de forma autónoma. Los componentes desmontables, asociados al respaldo abatible, permiten que el propio usuario pueda desmontar la silla, por ejemplo para colocarla en el carro. El respaldo acolchado y el asiento se ajustan a través de fajas de tensión. El respaldo tiene una inclinación hasta 12°, es ajustable en altura hasta 8cm y completamente plegables hacia adelante para ahorro de espacio durante el transporte. Asiento ajustable en profundidad hasta 6cm y en inclinación hasta 12°. Salva ropa ajustable en altura y removible. El reposapiés es ajustable en altura y ángulo. Ruedas traseras de Ø600mm hinchables con quick release y camber variable 0° a 8°. Asiento ajustable en altura de 44 a 50cm, con inclinación de 14° a -4°.

Disponible en España



ACTIVA 4LIFE 36	54	36	34	74-80	60	44-50	34-40	78	78	36-42	80°-100°	120	6,2-9,8
ACTIVA 4LIFE 38	59	38	34	78-84	72	44-50	34-42	87	78	42-52	90°-102°	120	6,2-9,8
ACTIVA 4LIFE 40	64	40	34	78-84	72	44-50	34-42	87	78	42-52	90°-102°	120	6,2-9,8
ACTIVA 4LIFE 44	68	44	34	78-84	72	44-50	34-42	87	78	44-52	90°-102°	120	6,2-9,8
ACTIVA 4LIFE 48	72	48	34	78-84	72	44-50	34-42	87	78	42-52	90°-102°	120	6,2-9,8

ATIVA SIOUX



ATIVA SIOUX	
51 CD SI 2 NO 40/43/46 ED	
Ruedas delanteras- macizas Front wheels- solid	Ø100mm
Ruedas traseras- macizas Back wheels- solid	Ø600mm
Llantas traseras Rear rims	rayadas spokes
Color- estructura Colour-structure	gris, negro, azul o rojo grey, black, blue, red
Color tapicería Colour upholstery	negro black
Tallas disponibles Available sizes	40/43/46cm
Peso total Total weight	10,8kg
Peso máximo de usuario Maximum user weight	125kg

51 CD SI 2 NO 40/43/46 ED

ATIVA SIOUX, silla en aluminio muy ligera (peso sin ruedas: 7,2Kg). Con chasis rígido, resistente y funcional. Con altura y profundidad regulables. Respaldo y asiento rígidos. Almohada de respaldo y cojín de asiento en Memory Foam para mayor confort. Respaldo plegable, regulable en inclinación. Altura, profundidad y inclinación del asiento ajustables. Reposapiés único ajustable en altura. Salva ropa. Ruedas traseras 600mm hinchables con extracción rápida y llanta enrayada, lo que permite un fácil almacenamiento y transporte. Ruedas delanteras macizas de 100mm. Ancho asiento: 370, 400, 430, 460, 500mm. Peso máximo usuario: 125Kg.

ATIVA SIOUX, active and light wheelchair made of aluminium (weight without wheels: 7,2Kg). Rigid chassis, resistant and functional. Height and depth adjustments. Solid back and seat. Back and seat memory foam cushions for maximum comfort. Foldable backrest, angle adjustable. Height, depth and angle adjustment of the seat. Unique footrest height adjustable. Side panels. Pneumatic 600mm rear wheels with quick release and spoke rims allows easy storage and transport. 100mm solid front wheels. Seat width: 370, 400, 430, 460, 500mm. Maximum user weight: 125Kg.

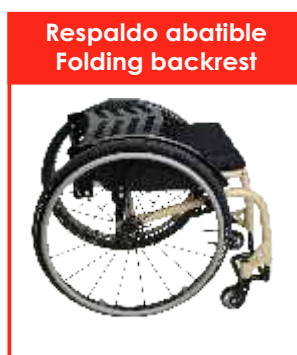

	51	51	51	51	51	51	51	51	51	51	51
ATIVA SIOUX 40	58	40	30	89-99	73	51	34-44	91	42-44	125	9,6
ATIVA SIOUX 43	61	43	30	89-99	73	51	34-44	91	42-44	125	9,6
ATIVA SIOUX 46	64	46	30	89-99	73	51	34-44	91	42-44	125	9,6

PROFILE LIGHT



51 CD LL 4 PL 40/42/44/46

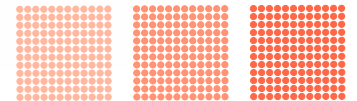

La elegancia y el alto rendimiento son las palabras que caracterizan a la nueva ACTIVA PROFILE LIGHT, recomendada para usuarios activos. Con una estructura ligera y compacta en aluminio permite una conducción fluida, rápida y deportiva. Permite diversos ajustes a nivel del respaldo, asiento y reposapiés. Respaldo acolchado, con fajas tensoras ajustables, abatible para facilitar el transporte y el almacenaje. Asiento con base rígida flexible en la zona isquiotibial (amortiguación de los impactos, cuando se usa en pisos exteriores irregulares) y cojín de confort de serie. Respaldo ajustable en ángulo 25° (85°-110°) y en altura 100mm (mínimo 320mm para permitir la máxima libertad del usuario). Asiento ajustable en profundidad +140mm y en ángulo. Con salva ropa. Reposapiés único, regulable en altura y abatible. Ruedas traseras hinchables de 600mm extraíbles y ruedas delanteras macizas de 100mm. Camber variable 0° a 8°. Sistema de freno compacto para no interferir en los traslados. Los componentes desmontables, asociados al respaldo abatible y bajo peso de la silla (total aprox. 10Kg) permiten que el usuario la coloque fácilmente en el coche.

Disponible en varias tallas.

PROFILE LIGHT

51 CD LL 4 PL 40/42/44/46

Rueda delantera maciza	Ø100mm
Rueda trasera hinchable	Ø600mm
Color estructura	gris, negro, azul o rojo
Tallas disponibles	40/42/44/46cm
Color tapicería	negro
Peso máximo de usuario	120kg
Peso total	11,9kg



Disponible en España



PROFILE LIGHT

58-72

36-50

74-88

-

50-55

32-42

71









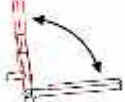

36+14

85° - 110°

120

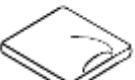
11,9

Accesorios & Opciones

					
14.81 Reposacabezas	21.82 Reposacabezas postural	14.82 Reposacabezas	14.01M Manija ajustable en altura	14.78/E Reposabrazos de mesa (17.70N)	14.04 Reposabrazos mesa ajustable en altura (17.68N/17.70N)
					
14.78/C Reposabrazos tubular (17.70N)	14.78/4L Reposabrazos abatible (12.70N/12.72)	13.48 Soporte de tronco	13.48A Soporte de tronco swing away (12.70N/12.72)	13.58 Abdutor (17.68N/17.70N)	14.78A Salva ropa de fibra de carbono (17.70N)
					
14.78-4LAN Salva ropa aluminio (12.70N)	14.78-4LCA Salva ropa carbono (12.70N/12.72)	14.51U Tablero transparente (17.68N/17.70N)	14.54U Tablero rígido ABS (17.68N/17.70N)	14.51U Tablero transparente plegable (17.68N/17.70N)	14.54UR Tablero rígido ABS plegable (17.68N/17.70N)
					
14.34E Respaldo reclinable (manual) (17.68N)	14.33DM4L Respaldo reclinable (pistones) (12.70N)	14.87 Fajas tensoras (17.68N)	13.40 Respaldo Acollchado	21.06 Almohada comfort back	21.06B Almohada comfort back
					
21.14 Almohada 3D soft seat	21.30 Almohada 3D soft seat (17.68N/17.70N)	22.56E Almohada PU	14.86 Asiento sanitario (17.68N)	13.08/4L Suspensión trasera (12.70N)	13.20 Freno de cuidador
					
13.81D/S Freno unilateral	13.61D/S Comando unilateral	13.54 Rueda con doble mando (17.68N/17.70N)	13.65 Eje retrasado	13.10E Rueda ø300mm (17.68N)	14.75 Reposapiés elevables (17.68N)
					
14.73A Reposapiés (17.70N)	21.84EVL Reposapiés ajustable en ángulo (17.68N/17.70N)	14.70 Reposapiés único aluminio (17.68N)	14.22TO Reposapiés único reb. ajust. en ángulo (17.68N/12.70N/12.72)	14.22 Reposapiés plegable (17.70N)	13.47 Ruedas antivuelco (17.68N/17.70N)
					
13.47EV Ruedas antivuelco plegables (17.68N/17.70N)	13.46-4L Ruedas antivuelco (12.70N/12.72)	13.46-4LD Ruedas antivuelco (12.70N)	13.44 Ruedas extra (17.68N/17.70N/12.70N)	13.70 Cubre radios transparente	13.70C Cubre radios colorido
					
13.05 Soporte bastones (17.68N/17.70N/12.70N)	13.12 Soporte suero (17.68N/17.70N)	13.38U Soporte oxígeno (17.68N/17.70N)			

SILLAS DE POSICIONAMIENTO POSITIONING WHEELCHAIRS

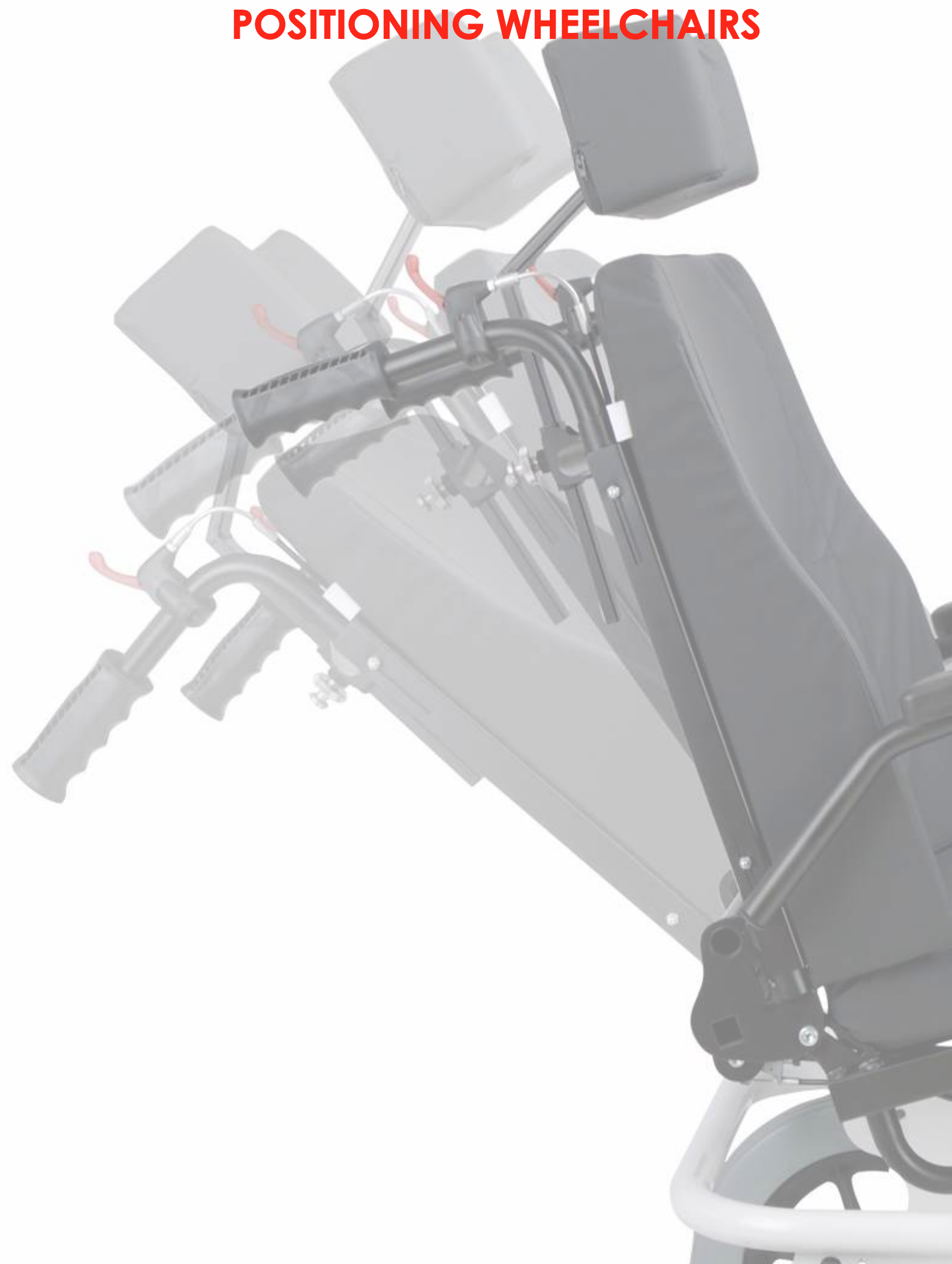

CARIBE

CARIBE

51 CD PO CR 40/43/46/50

Reclinación máxima Maximum recline	89°-114° / 96°-120°(neumático) 89°-114° / 96°-120°(pneumatic)
Basculación Tilt / Recline	0°-30° (neumático) 0°-30° (pneumatic)
Ruedas delanteras - macizas Front wheels - solid	Ø200mm
Ruedas traseras - macizas Back wheels - solid	Ø300mm/ Ø600mm
Tallas disponibles Available sizes	40/43/46/50cm
Ajuste de profundidad de asiento Seat's depth adjustment	40-50cm
Color de la estructura Structure's colour	blanco o gris white or grey
Peso sin componentes desmontables Weight without detachable components	32,5kg
Peso total Total weight	40,5kg
Peso máximo de usuario Maximum user weight	150kg



Asiento y respaldo rígidos Rigid seat and backrest

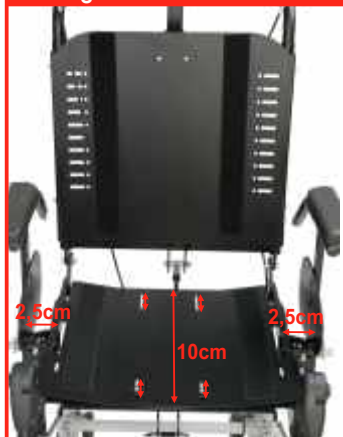

CARIBE, silla de posicionamiento que ofrece máxima adaptabilidad a las necesidades del usuario. En acero, con reclinación (89° a 114° o 96° a 120°) y basculación (0° a 30° o -5° a 25°) por bomba de gas. Garantiza el correcto posicionamiento y la seguridad del usuario. Respaldo rígido regulable en altura con cójín Comfort Back lateral en PU. Asiento regulable en profundidad (400mm a 500mm), en anchura (hasta + 5cm) y ángulo, con cójín Comfort Seat en PU. Puños ajustables en altura. Reposabrazos regulables en altura y profundidad, reposapiés elevables y ruedas anti-vuelco. Reposacabezas en forma de U ajustable en altura y ángulo. Opción: basculación y reclinación manuales; ruedas traseras de Ø300mm o Ø600mm. Amplia gama de accesorios y opciones. Consultenos!

CARIBE, positioning chair that provides maximum adaptability to user needs. Made of steel, with pneumatic recline (89° a 114° or 96° a 120°) and tilt (0° a 30° or -5° a 25°). Ensures correct positioning and user's safety. Height adjustable rigid back with Comfort Back lateral cushion. The seat is adjustable in depth (400mm to 500mm), width (up to 5cm) and angle with Comfort Seat cushion. Height adjustable handles. Height and depth adjustable armrests, elevating footrests and anti-tipping wheels. U shape headrest is adjustable in height and angle. Option: manual tilt and recline; Ø300mm or Ø600mm back wheels. Wide range of accessories and options. Consult us!

Reposacabezas Headrest	Reposabrazos ajustable Adjustable armrests	Reposapiés elevables Elevating footrests	Freno de estacionamiento Parking brake	Ruedas antivuelco Anti tipping wheels	Reclinación y basculación max. Max. tilt and recline

	Ø300mm	Ø600mm													
CARIBE 40	58	66	40	110-129	66-78	47-51	55-70	104-114	90	40-45	96°-120°	0°-30°	150	40,5	
CARIBE 43	58	66	43	110-129	66-78	47-51	55-70	104-114	90	40-45	96°-120°	0°-30°	150	40,5	
CARIBE 46	61	66	46	110-129	66-78	47-51	55-70	104-114	90	45-50	96°-120°	0°-30°	150	40,5	
CARIBE 50	65	67	50	110-129	66-78	47-51	55-70	104-114	90	45-50	96°-120°	0°-30°	150	40,5	



Contra-basculación



Respaldo reclinable



Basculación



Posibilidad de girar las aspas



51 CD PO VP RG

Silla de posicionamiento indicada para usuarios que necesiten cambios frecuentes de posición. Posibilita la reclinación del respaldo hasta 60° y basculación hasta 45° a través de bomba de gas. Además de este sistema único de basculación por bomba de gas, el asiento y el respaldo son acolchados en formato anatómico. El reposacabezas y los reposabrazos son debidamente acolchados, ajustables y desmontables. Para máxima seguridad, posee ruedas antivuelco. Con este sistema de basculación, la ropa del usuario no sube ni desliza en el respaldo, permitiendo siempre una posición muy cómoda. Reposacabezas y ruedas antivuelco incluido en la configuración estándar. Ver accesorios.

VARIO PLUS 12.17 N	
51 CD PO VP RG	
Rueda delantera maciza	Ø175mm
Rueda trasera hinchable	Ø600mm
Color estructura	gris
Color tapicería	negro
Peso máximo del usuario	120kg
Peso total	30kg

Soporte de las rodillas 13.43
(no compatible con AB muslos)

Altura y profundidad 14.70R

VARIO PLUS AEROPORTO 12.17T	
51 CD PO VP	
Rueda delantera maciza	Ø175mm
Rueda trasera neumática	Ø300mm
Color estructura	gris
Color tapicería	negro
Peso máximo del usuario	120kg
Peso total	28kg

Disponible en España

VARIO PLUS 12.17 T	66	45	-	57	60	117	45-50	60°	45°	120	27-30
VARIO PLUS 12.17 N	66	45	-	57	60	117	45-50	60°	45°	120	27-30

CARIBE ADVANCE

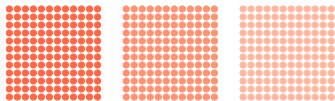

CARIBE ADVANCE

51 CD PO CR (40 50)/(50 60)

Reclinación Recline	89°-114° / 96°-120°(neumático) 89°-114° / 96°-120°(pneumatic)
Basculación Tilt / Bascule	0°-30° / -5°-25° (neumático) 0°-30° / -5°-25° (pneumatic)
Ruedas delanteras - macizas Front wheels - solid	Ø200mm
Ruedastraseras-macizas Back wheels - solid	Ø300mm / Ø400mm / Ø600mm
Llantas Rims	nylon/rayadas nylon/spoked
Tallas disponibles Available sizes	40/43/46/50cm
Profundidad de asiento ajustable Adjustable seat's depth	40-50cm
Anchura de asiento ajustable Adjustable seat's width	40-50cm
Color de la estructura Structure's colour	blanco o gris white or grey
Peso sin componentes desmontables Weight without detachable components	33kg
Peso total Total weight	41kg
Peso máximo de usuario Maximun user weight	150kg

CARIBE ADVANCE es una silla ajustable a las necesidades del usuario, proporcionando innumerables puntos de fijación a nivel del asiento y del respaldo.

Silla de posicionamiento en acero, con reclinación (89° a 114° o 96° a 120°) y basculación (0° a 30° o -5° a 25°) por bomba de gas. También disponibles modelos con reclinación y basculación mecánicas. Seating system totalmente modular compuesto de chapas ajustables e independientes permitiendo amplios ajustes en anchura, profundidad y altura.

Respaldo rígido ajustable en altura, con 2 fajas de tensión para regulación de tensión sacro-lumbar y almohada Comfort Back lateral. Asiento rígido regulable en profundidad (de 400mm a 500mm), anchura (400mm a 500mm) y en ángulo con cójin Comfort Seat. Varias opciones de cojin disponibles. Puños ajustables en altura y 4 puntos de agarra para transporte.

Equipada con ruedas traseras macizas de Ø300mm, Ø400mm o Ø600mm y ruedas delanteras macizas de Ø200mm. Freno de aparcamiento y freno de cuidador de tambor. Amplios reposabrazos Comfort con funda en bielástico, en T son regulables en altura y profundidad. Reposapiés elevables, con apertura lateral y ajuste de profundidad (50mm). Ruedas antivuelco destacables y ajustables. Reposacabezas en forma de U ajustable en altura, ángulo y profundidad.

Amplia gama de accesorios y opciones disponibles. Consultenos!

Freno de cuidador de tambor
Attendant's drum brake



Reposabrazos regulables
Adjustable armrests



Freno de estacionamiento
Parking brake



Reposapiés elevables
Elevating footrests



Respaldo rígido con fajas tensoras
Rigid backrests with tension back straps

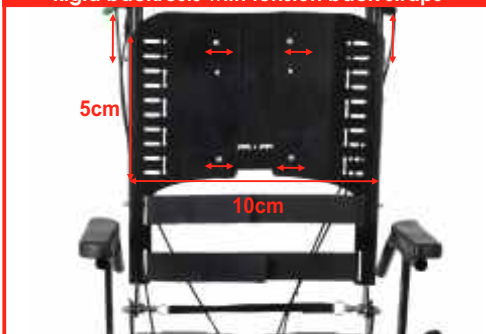

Asiento rígido ajustable
Adjustable rigid seat

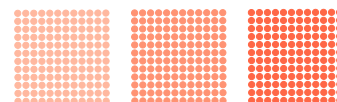
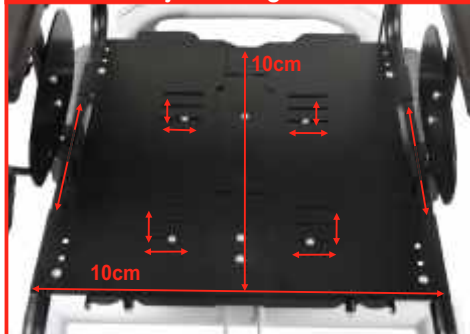

CARIBE ADVANCE is an adjustable wheelchair to user needs, providing numerous points of attachment to the seat and backrest. Positioning wheelchair made of steel, with pneumatic recline (0° to 30° or - 5° to 25°) and tilt (89° to 114° or 96° to 120°). Also, available model with mechanic tilt and recline. Seating system fully modular with adjustable and separate plates allowing extensive adjustments in width, depth and height. Height adjustable rigid back plate with 2 tension lower back straps with lateral Comfort Back cushion. Adjustable rigid seat, in depth (from 400mm to 500mm), width (400mm to 500mm) and angle (1° to 30° or - 5° to 25°) with Comfort Seat cushion. Several options available for seat and backrest cushions. Height adjustable handles and transport kit with 4 fixation points for transport. Equipped with Ø400mm solid rear wheels and Ø200mm front solid wheels. Parking and attendant 's brakes. T shape armrests adjustable in height and depth with Comfort pad. Elevating footrests with side opening and depth adjustment (50mm). Adjustable and removable anti-tipping wheels. U shape headrest is adjustable in height, angle and depth.

Wide range of accessories and options available. Consult us!

Reposacabezas
Headrest



Ruedas antivuelco
Anti tipping wheels



Ø300mm Ø600mm
Ø400mm

CARIBE ADVANCE 40	58	66	40-50	110-129	66-78	47-51	55-70	104-114	90	40-45	89°-114°	0°-30°	150	41
CARIBE ADVANCE 43	58	66	40-50	110-129	66-78	47-51	55-70	104-114	90	40-45	89°-114°	0°-30°	150	41
CARIBE ADVANCE 46	61	66	40-50	110-129	66-78	47-51	55-70	104-114	90	45-50	89°-114°	0°-30°	150	41
CARIBE ADVANCE 50	65	67	40-50	110-129	66-78	47-51	55-70	104-114	90	45-50	89°-114°	0°-30°	150	41

Accesorios & Opciones

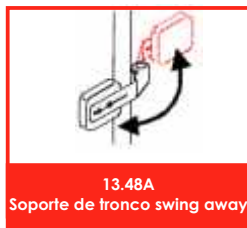

SILLAS ELÉCTRICAS **ELECTRIC WHEELCHAIRS**



AZTECA

Respaldo ajustable en tensión
Tension adjustable backrest



Ruedas antivuelco
Anti-tipping wheels



51 CD EL 2 AZ 40 AP

AZTECA 51 CD EL 2 AZ 40/43/46 AP

Rueda delantera - hinchable Front wheel - pneumatic	Ø200mm
Rueda trasera - hinchable Rear wheel - pneumatic	Ø300mm
Color - estructura Colour - structure	blanco white
Color - tapicería Colour - upholstery	negro black
Baterías de AGM sin mantenimiento Maintenance free AGM batteries	12V 42AH
Cargador de baterías Batteries charger	24V e 5A
Motor - potencia Engine - power	180w / 200w
Autonomía Autonomy	25km*
Velocidad máxima hacia adelante Maximum speed forward	6km/h*
Velocidad máxima hacia atrás Maximum speed reverse	3km/h*
Radio de rotación Rotation radius	92cm
Peso total Total weight	67kg
Peso máximo usuario Maximum user's weight	125kg

(*en condiciones normales de suelo y peso de
utilizador)
(*in normal pavement and user's weight conditions)

AZTECA se distingue por su sencillez y robustez, aliadas a confort y estabilidad. Los mandos de control incorporan la más moderna tecnología, con diseño atractivo y ergonómico, proporcionando una conducción suave y fácil.

El respaldo acolchado permite la regulación con fajas tensoras sacro-lumbar. Reposabrazos destacables y reposapiés destacables y ajustables en altura. Las cajas de baterías son desmontables, facilitando el pliegue de la silla para su transporte. Incluye ruedas antivuelco. Con dimensiones compactas para fácil maniobrabilidad. **Ver accesorios y opciones.**

AZTECA is plain and robust, comfortable and stable. The control commands integrate the most modern technology, with attractive and ergonomic design. The motors enable an easy and smooth drive.

*The tension regulating straps at the back provide additional comfort. Removable armrests and height adjustable and removable footrests. The batteries boxes are removable for ease of transport. With anti-tippers. Very compact dimensions for easy manouvrability. **See accessories and options.***

Accesorios Accessories:

Reposacabezas Head rest	Abductor	Cójin de memory foam Memory foam seat	Reposapiés elevable Elevating leg rest	Trepa paseo Step climber

(no es compatible con almohada
de asiento/ not compatible with
seat cushion)



AZTECA 40
AZTECA 43
AZTECA 46

59	40	38	92	72	52	41	106	84	42	92	125	67
61	43	41	92	72	52	41	106	84	42	92	125	67
64	46	44	92	72	52	41	106	84	42	92	125	67

EVOLUTION 17.82

51 CD EL 4 EV 42/46

Rueda delantera hinchable	Ø200mm
Rueda trasera hinchable	Ø300mm
Color estructura	azul
Color tapicería	negro
Baterías (sin mantenimiento)	42AH
Cargador de baterías	24V e 5A
Motor con una potencia	160W
Autonomía	35 a 40km*
Velocidad máxima hacia adelante	7,5km/h*
Velocidad máxima marcha atrás	3km/h*
Rayo de rotación	107cm
Peso máximo del usuario	120kg
Peso total	70kg
(* en condiciones normales de piso y peso del usuario)	



51 CD EL 4 EV 42

Disponible en España

EVOLUTION, la silla eléctrica de acero barnizado en alta resistencia con cruceta doble. Se puede cerrar, retirando las baterías para facilitar el transporte. Respaldo ajustable en altura. Reposapiés ajustables en altura, desmontables, giratorios y retráctiles y reposabrazos abatibles. El asiento tiene un sistema que permite aumentar su profundidad en 8cm. Incluye ruedas antivuelco.

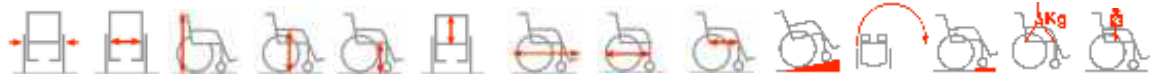

EVOLUTION 36	54	36	82-90	68	50	35-43	92-100	72	36-42	10°	90	4	68-75	120
EVOLUTION 42	60-64	42	86-96	70-75	50	37-45	103-111	80-88	42-52	12°	107	4	70	120
EVOLUTION 46	60-64	46	86-96	70-75	50	37-45	103-111	80-88	42-52	12°	107	4	70	120

Accesorios & Opciones

VICKING



VICKING, silla eléctrica en acero con 2 motores de 180/200W de bajo consumo y freno electromagnético. Garantiza el correcto posicionamiento y seguridad del usuario, Respaldo con fajas tensoras integradas, almohada Flexible Back en viscoelástico y funda 3D. Asiento rígido ajustable en anchura (50mm) a través del reposabrazos y en profundidad (400mm a 500mm en continuo), con c j n Comfort Seat. Equipada con ruedas traseras macizas de Ø300mm y ruedas macizas delanteras de Ø200mm. Reposabrazos en T, ajustables en altura y profundidad y destacables con mando escamoteable. Reposapi s con apertura bilateral y ajuste en profundidad. Ruedas anti-vuelco. Opciones: inclinaci n y basculaci n mec nicas, neum ticas o el ctricas; motor 200W/300W.

Ver accesorios y opciones.

VICKING, electric wheelchair made of steel, with 2 engines of 180/200W low consumption and electromagnetic brakes. Ensures the right positioning and security of the user with tension backstraps and 3D cover flexible backrest. Rigid seat, adjustable in width (50mm) through the armrest and in depth (400mm to 500mm continuously), with Comfort Seat cushion. Equipped with solid rear wheels Ø300mm and solid front wheels Ø200mm. Height and depth adjustable T shape armrests, with swing-away joystick. Footrests with bilateral opening and depth adjustment. Anti-tipping wheels. Options: manual, pneumatic or electric tilt and bascule.

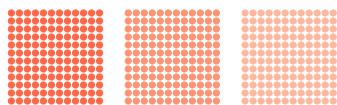

VICKING

51 CD EL VK 40/43/46/50

Reclinaci�n m�xima Maximum recline	130�(mec�nico)/120�(neum�tico/el�ctrico) 130�(mechanic)/120�(pneumatic/electric)
Basculaci�n Tilt/Recline	0�/30�(mec.); -5�/25� (neum�tico/el�ctrico) 0�/30� (mechanic); -5�/25� (pneumatic/electric)
Ruedas delanteras - hinchables o macizas Front wheels - pneumatic or solid	Ø200mm
Ruedas traseras - hinchables o macizas Back wheels - pneumatic or solid	Ø300mm
Color de la estructura Structure's colour	blanco o gris white or grey
Velocidad m�xima hacia adelante Maximum speed forward	6km/h*
Velocidad m�xima hacia atr�s Maximum reverse speed	3km/h*
Motor Engine	200W/ 24V
Bater�as de AGM sin mantenimiento Maintenance free AGM batteries	12V 42AH
Cargador de bater�as Batteries charger	24V, 5A
Autonom�a Autonomy	25km
Peso m�ximo de usuario Maximum user weight	150kg

Reclinaci n y basculaci n Tilt and recline



Fajas tensoras Tensioning backstraps



Mando Joystick



Asiento r gido ajustable en profundidad Depth adjustable rigid seat

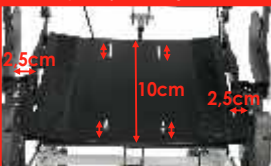

(*en condiciones normales de suelo y peso de usuario)
(*in normal pavement and user's weight conditions)



VICKING 40	62	40	107-122	66-80	47-51	55-70	102-107	76-81	40-45	90�-130�	0�-30�	150
VICKING 43	62	43	107-122	66-80	47-51	55-70	102-107	76-81	40-45	90�-130�	0�-30�	150
VICKING 46	62	46	107-122	66-80	47-51	55-70	102-107	76-81	45-50	90�-130�	0�-30�	150
VICKING 50	62	50	107-122	66-80	47-51	55-70	102-107	76-81	45-50	90�-130�	0�-30�	150

VICKING ADVANCE



VICKING ADVANCE, silla eléctrica en acero con 2 motores de 180/200W de bajo consumo y freno electromagnético. Garantiza el correcto posicionamiento y seguridad del usuario, con su respaldo con fajas tensoras y funda 3D. Seating system totalmente modular compuesto de chapas ajustables e independientes permitiendo amplios ajustes en anchura, profundidad y altura. Asiento rígido ajustable en anchura (400mm a 500mm en continuo) y en profundidad (400mm a 500mm en continuo), con cójin Comfort Seat. Equipada con ruedas traseras macizas de Ø300mm (opción: Ø350mm con motor de 300W) y ruedas delanteras hinchables de Ø200mm. Reposabrazos en T, ajustables en altura y profundidad, destacables con mando fijo. Reposapiés con apertura bilateral y ajuste en profundidad. Ruedas antivuelco. Puños ajustables en altura.

Opciones: inclinación y basculación mecánicas, neumáticas o eléctricas.

Ver accesorios y opciones.

VICKING ADVANCE, electric wheelchair made of steel, with 2 engines of 180/200W low consumption and electromagnetic brakes. Ensures the right positioning and security of the user with tension back straps and 3D cover flexible backrest. Seating system fully modular with adjustable and separate plates allowing extensive adjustments in width, depth and height. Rigid seat, adjustable in width (400mm to 500mm continuously) and in depth (400mm to 500mm continuously), with Comfort Seat cushion. Equipped with solid rear wheels Ø300mm (option: Ø350mm and 300W engine) and pneumatic front wheels Ø200mm. Height and depth adjustable T shape armrests, with joystick. Footrests with bilateral opening and depth adjustment. Anti-tipping wheels. Height adjustable handles. Options: manual, pneumatic or electric tilt and recline.

See accessories and options.

VICKING ADVANCE 51 CD EL VK 40 50

Reclinación máxima Maximum recline	130°(mec)/120°(pneum/eléctrico) 130°(mec)/120°(pneum/electric)
Basculación Tilt/Recline	0°/30° (mecánico) -5°/25° (neumático/eléctrico) 0°/30° (mechanic) -5°/25° (pneumatic/electric)
Ruedas delanteras - hinchables Front wheels - pneumatic	Ø200mm
Ruedas traseras - hinchables Back wheels - pneumatic	Ø300mm/Ø350mm
Color de la estructura Structure's colour	blanco o gris white or grey
Velocidad máxima hacia adelante Maximum speed forward	6km/h*
Velocidad máxima hacia atrás Maximum reverse speed	3km/h*
Motor Engine	200W / 24V; 300W
Baterías de AGM sin mantenimiento Maintenance free AGM batteries	12V 42AH
Cargador de baterías Batteries charger	24V, 5A
Autonomía Autonomy	25km
Peso máximo de usuario Maximum user weight	150kg

(*en condiciones normales de suelo y peso de usuario)
(*in normal pavement and user's weight conditions)



Respaldo ajustable con fajas tensoras
Adjust. backrest with tensioning back straps



Asiento rígido ajustable
Adjustable rigid seat

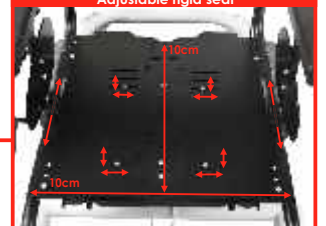

VICKING ADVANCE, adecuada para usuarios con problemas de movilidad que requieren un buen soporte postural y cambios frecuentes de posición.

VICKING ADVANCE, suitable for users with mobility problems who require a good postural support and that need frequent positioning change.



VICKING ADVANCE 40	62	64	40-50	107-122	66-80	47-51	55-70	102-107	76-81	40-45	90°-130°	0°-30°	150
VICKING ADVANCE 43	62	64	40-50	107-122	66-80	47-51	55-70	102-107	76-81	40-45	90°-130°	0°-30°	150
VICKING ADVANCE 46	62	64	40-50	107-122	66-80	47-51	55-70	102-107	76-81	45-50	90°-130°	0°-30°	150
VICKING ADVANCE 50	62	64	40-50	107-122	66-80	47-51	55-70	102-107	76-81	45-50	90°-130°	0°-30°	150

VICKING SUSPENSION



VICKING SUSPENSION 51 CD EL VK SU 40 50

Reclinación máxima Maximum recline	90°-130°/96°-120°
Basculación Tilt/Recline	0°-30°/ -5° -24°
Ruedas delanteras - hinchables Front wheels - pneumatic	Ø200mm
Ruedas traseras - hinchables Back wheels - pneumatic	Ø300mm / Ø350mm
Color de la estructura Structure's colour	blanco o gris white or grey
Velocidad máxima hacia adelante Maximum speed forward	6km/h*
Velocidad máxima hacia atrás Maximum reverse speed	3km/h*
Motor Engine	200W / 24V; 300W
Baterías de AGM sin mantenimiento Maintenance free AGM batteries	12V 50AH
Cargador de baterías Batteries charger	24V, 5A
Autonomía Autonomy	25km
Peso máximo de usuario Maximum user weight	150kg

(*en condiciones normales de suelo y peso de usuario)
(*in normal pavement and user's weight conditions)

VICKING SUSPENSION, silla de ruedas eléctrica, totalmente ajustable, diseñada para uso exterior, con sistema de suspensión integrado. Garantiza el correcto posicionamiento y seguridad del usuario. Con mando a la derecha (de serie), siendo posible colocarlo a la izquierda. Costas con fajas tensoras con revestimiento con almohadilla capa 3D. Asiento modular compuesto por placas rígidas ajustables continuamente en ancho (de 400 a 500mm) y en profundidad (de 400 a 500mm), con cojín Comfort Seat 3D. Con reclinación mecánica y basculación eléctrica (otras opciones disponibles). Reposabrazos en "T" regulables en altura y profundidad, destacables. Reposapiés con apertura bilateral, ajuste en altura y profundidad. Ruedas neumáticas traseras 300mm (opción: 350mm con motores de 300W) y delanteras 200mm. Ruedas antivuelco. Baterías AGM 12V 50Ah sin necesidad de mantenimiento. Motores de 200W. Autonomía 25Km. Velocidad máxima 6Km/h, en condiciones normales de piso y peso de usuario. Varias opciones de configuración y accesorios (consultar order form).

VICKING SUSPENSION, electric wheelchair, fully adjustable, designed for outdoor use, with integrated suspension system. It guarantees the correct positioning and security of the user. With right hand control (standard), it can be placed on the left. Straps with tensioning straps with cushion cover with 3D cover. Modular seat composed of rigid plates continuously adjustable in width (from 400 to 500mm) and in depth (from 400 to 500mm), with Comfort Seat 3D pad. With mechanical recline and electric tilting (other options available). Supports T-armrests adjustable in height and depth, detachable. Footrests with bilateral opening, height and depth adjustment. Pneumatic rear wheels 300mm (option: 350mm with motors of 300W) and front 200mm. Anti-fall wheels. Batteries AGM 12V 50Ah without maintenance. 200W motors. Autonomy 25Km. Maximum speed 6Km/h, under normal floor conditions and user weight. Various configuration options and accessories (see order form).

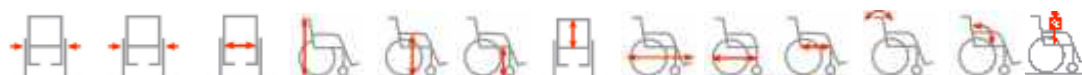

VICKING SUSPENSION 43

Ø300mm
62

Ø350mm
64

40-50

105

70-75

47-51

52

102-107

80















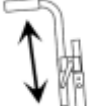

















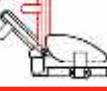





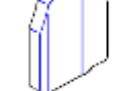

















40-50

90°-130°

0°-30°

150

Accesorios & Opciones

 14.81 Reposacabezas en U	 14.82 Reposacabezas	 14.83D Reposacabezas dinámico	 21.78 Reposacabezas ajustable	 21.80N Reposacabezas occipital envolvente	 14.01ME36 Puño ajustable en altura (18.82AB)	 14.98 Mando mentoniano
 14.99BR Mando mentoniano	 14.95 Mando duplo	 14.94U Mando de acompañante	 13.26C Mando abatible	 13.11 Protección de joystick	 14.96S Mando en el bandeja	 14.96B Bandeja abatible con mando abatible
 14.53PPD/S Bandeja recortada para mando	 14.51URE Bandeja transparente rebatible	 21.40 Soporte palmar (17.82N/18.82N/19.98N)	 13.00/S Reposabrazos cierre delantero 90°	 21.88 Reposabrazos contención bilateral (19.98N)	 14.04J Reposabrazos ajustable en altura (17.82N)	 14.78S Reposabrazos abatible ajustable altura (19.98N)
 14.05A Reposabrazos acompaña inclinación (19.98N)	 13.67 Almohadas interiores (17.82N/18.82N/19.98N)	 13.48 Soporte de tronco	 13.48A Soporte de tronco swing away	 13.58 Abductor (18.82N/17.82N)	 14.92B Respaldo reclinable eléctrico (18.82AB)	 14.34EE-36 Respaldo reclinable manual (17.82N/18.82N/19.98N)
 14.92S36 Respaldo reclinable eléctrico (18.82N/19.98N)	 14.33 E Respaldo dinámico (17.82N/19.98N)	 21.06 Respaldo anatómico fijo a la estructura	 21.06B Respaldo anatómico bandas tensoras	 21.06P E Respaldo postural superior lateral (18.82N/17.82N/19.98N)	 13.15SH Respaldo anatómico de fondo en tejido (18.82AB/18.82N/19.98N)	 13.15SC Respaldo anatómico fondo rígido (18.82AB/18.82N/19.98N)
 21.06F Placa rígida de respaldo (18.82AB/18.82N/19.98N)	 21.18FP Placa de asiento rígida (18.82N/19.98N)	 21.18F Placa de asiento rígida (18.82N/19.98N)	 13.15SD Asiento anatómico fondo en tejido (18.82AB/18.82N/19.98N)	 13.15SB A Asiento anatómico fondo rígido tela (18.82N/19.98N)	 22.56E Almohada PU (18.82N/17.82N/19.98N)	 14.74EB Reposapiés elevables (18.82AB)
 14.74ES Reposapiés de elevación eléctrica (18.82N/19.98N)	 14.74ESG Reposapiés eléctrica giratorio removible (18.82N/19.98N)	 14.74N Reposapiés elevador manual (18.82N/19.98N)	 14.74EPG Reposapiés elevadores manual giratorio desprendible	 14.73H Reposapiés ajustable en ángulo (18.82N/17.82N/19.98N)	 14.73B Reposapiés eléctrico (18.82AB)	 14.22TO Reposapiés único reb. ajust. en ángulo (17.82N)
 14.76/H Reposapiés único aluminio/nylon (18.82N/17.82N/19.98N)	 14.71DM Reposapiés dinámica (17.82N/19.98N)	 14.71DMT Reposapiés dinámico (17.82N/19.98N)	 13.27 Elevación eléctrica asiento (18.82AB/18.82N/19.98N)	 13.22 Basculación eléctrica (18.82AB/18.82N/19.98N)	 13.22A/SA Contra-basculación elét. (18.82N/19.98N)	 13.25 Tracción frontal (19.98N)
 13.41 Ruedas antivuelco (18.82N/17.82N)	 13.43 Ruedas antivuelco (18.82N/19.98N)	 13.41S1 Ruedas antivuelco (19.98N)	 13.41S2 Ruedas antivuelco (19.98N)	 13.12A Trepa paseo (18.82N/17.82N/19.98N)	 13.05 Soporte bastones (18.82AB)	 13.38 Soporte oxígeno (18.82AB)
 13.68 Kit luz (18.82AB/18.82N/17.82N)	 13.03 Espejo	(sólo disponible con tracción trasera)				

18.82 TILT 51 CD EL 3 TI 42/46

Roda delantera hinchable	Ø200mm
Roda trasera hinchable	Ø300mm
Color de la estructura	cinza
Color de la tapicería	pretos
Baterías	42 AH
Cargador de baterías	24V e 5A
Motor- potencia	160w
Autonomía	40km*
Velocidad máx hacia adelante	7,5km/h*
Velocidade máx hacia atrás	3km/h*
Raio de rotación	100cm
Peso máximo do usuario	120kg
Peso total	75kg

(*em condiciones normales de suelo y peso do usuario)



51 CD EL 3 TI 42

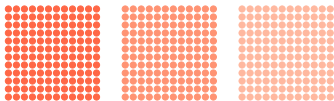

Opciones: Basculación eléctrica del asiento



21.78-Reposacabezas



13.22 HE- Basculación eléctrica



14.92 HE- Respaldo reclinable eléctrico



Encaje reclinable + basculación

La silla de ruedas de tracción eléctrica TILT, se caracteriza por su versatilidad y funcionalidad. Gracias a sus soluciones técnicas es posible variar la profundidad del asiento de 42 a 52cm y aumentar hasta 6cm a medida base en la anchura. Asiento ajustable en ángulo mediante columna telescópica situada debajo de éste, funciona como basculación manual, de serie. Los reposabrazos son regulables en altura y destacables. El asiento y el respaldo están dotados de fajas tensoras que permiten elegir la tensión que desea. El respaldo permite una reclinación de 15° y es plegable, facilitando el transporte. Reposapiés regulables en altura, abatibles y extraíbles. Incluye ruedas antivuelco.

Disponible en España



TILT 46	54	36	76-86	70-75	50	32-42	88	76	36-42	4	10°	100	90°-105°	75	120
TILT 42	63	42	88-98	70-75	50	32-42	100	76	42-52	4	10°	100	90°-105°	75	120
TILT 46	63	46	88-98	70-75	50	32-42	100	76	42-52	4	10°	100	90°-105°	75	120

SPACE



51 CD EL 6 SP 42

La silla eléctrica SPACE especialmente adecuada para uso en el exterior, pudiendo fácilmente ser usada en el interior, debido a sus dimensiones compactas. Su moderno diseño incluye soluciones técnicas innovadoras. Respaldo y asiento regulables en altura y profundidad, desde 40 hasta 52cm, compuestos por fajas tensoras revestidas con capa removible. Reposabrazos regulables en altura y desmontables.

Incluye ruedas antivuelco. Salva ropa desmontables y regulables en anchura hasta 7cm. Reposapiés ajustables y desmontables. Incluye kit de luces frontal abatible para facilitar la transferencia. Opción de colocación de ruedas de tracción delantera.

SPACE 19.98	
51 CD EL 6 SP 42/46	
Rueda delantera hinchable	Ø230mm
Rueda trasera hinchable	Ø360mm
Comp. eléctricos- potencia	80Ah
Dos baterías	65Ah
Incluye cargador de baterías	
Kit de luz	
Autonomía hasta 5h	45km
5 velocidades, siendo la máx.	10,5km/h
Peso máximo del usuario	120kg

Disponible en España



SPACE 36	65	36	84-89	70/75	52	32-44	102	76	36-42	12°	120	4	90°/105°	116	100
SPACE 42	65	42	84-99	70/75	52	31-46	105	77	42/52	12°	120	6	90°/105°	116	120
SPACE 46	65	46	84-99	70/75	52	31-46	105	77	42/52	12°	120	6	90°/105°	116	120

SPACE TRACCIÓN DELANTERA



Opciones:



14.92S + 14.74S- Reclinación del respaldo y reposapiés elevadores



13.27- Subir eléctrico del asiento hasta 35 cm



13.22- Basculación eléctrica hasta 25°

SPACE TRACCIÓN DELANTERA

51 CD EL 6 SP42/46
99 51 GRD IV

R. delantera hinchab	Ø300mm/Ø360mm
R. trasera hinchable	Ø200mm / Ø230mm
Color estructura	vermelha
Color estructura	pretos
Baterías (sin mantenimiento)	65 AH
Cargador de baterías	24V e 8A
Potencia del motor	350w
Autonomia	45km*
Velocidad máx. adelante	12km/h*
Velocidad máx. marcha atrás	5km/h*
Radio de rotación	120cm
Peso máximo del usuario	120kg
Posibilidad de ser reforzada hasta	140kg
Peso total	116kg

* en condiciones normales de piso y peso del usuario

Disponible en España



SPACE 42	65	42	84-99	70-75	50	31-46	116	94	42-52	12°	6	120	90°-105°	116	120
SPACE 46	65	46	84-99	70-75	50	31-46	116	94	42-52	12°	6	120	90°-105°	116	120

4X4



New 4X4, silla eléctrica diseñada para uso exterior, incluso en pisos inestables, como por ejemplo pisos arenosos. Debido a las dimensiones reducidas también se puede utilizar fácilmente en ambiente domiciliario. Simple de usar, se adapta a todo tipo de terreno. Debido a la tracción a las 4 ruedas, esta potente y robusta silla es capaz de superar fácilmente obstáculos hasta 100mm de altura. Con un diseño atractivo y moderno y una estructura robusta y duradera que combina duraluminio y acero. Mando para control eléctrico colocado a la derecha o a la izquierda, posibilita la propulsión de la silla, así como funciones de elevación eléctrica del asiento (desde 430 a 550mm) y reclinación eléctrica del respaldo.













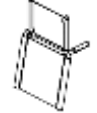















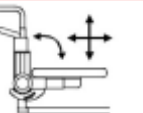



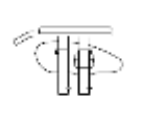

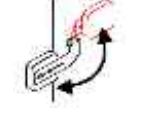











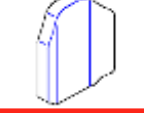

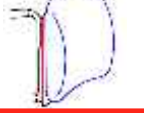













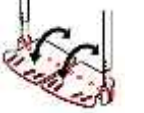

Respaldo y asiento con fajas tensoras. Asiento ajustable en ancho (en 60mm) y en profundidad (+100mm). Reposacabezas ajustable. Reposabrazos desmontables, regulables en altura. Reposapiés regulables en altura. Ruedas hinchables anchas. Con 4 motores de tracción de 260W. Posibilidad de seleccionar uso con tracción a 4 o 2 ruedas. Baterías de litio 40Ah fácilmente extraíbles y sin necesidad de mantenimiento. Ancho de asiento 420mm o 460mm (también disponible talla junior: 360mm). Posibilidad de aplicación de varios accesorios (ej: ruedas XXL para terrenos arenosos, basculación eléctrica, etc.).

4X4 51 CD EL 3 TT 42/46	
R. delantera hinchable	Ø260mm
R. trasera hinchable	Ø260mm
Color tapicería	negro
Color estructura	naranja, gris
Baterías (sin mantenimiento)	40 AH
Cargador de baterías	24V e 8A
Potencia del motor	260w
Autonomía	40km*
Velocidad máx. adelante	8km/h*
Velocidad máx. marcha atrás	5km/h*
Radio de rotación	160cm
Peso máximo del usuario	120kg
Peso total	92kg
(* en condiciones normales de piso y peso del usuario)	

Disponible en España



Accesorios & Opciones

 14.82 Reposacabezas	 14.83 Reposacabezas dinámico	 14.81A Reposacabezas ajustable	 21.82E Reposacabezas occipital	 14.81EN Reposacabezas postural fijo	 21.80E Reposacabezas occipital envolvente	 21.78EN Reposacabezas ajustable
 14.98 Mando mentoniano	 14.99BR Mando mentoniano	 14.95 Mando duplo	 14.94 Mando de acompañante	 13.26C Mando abatible (18.82N)	 13.11 Protección de mando	 14.96S Bandeja abatible con mando abatible
 14.96 Bandeja abatible con mando fijo	 14.53MMD/S Bandeja recortada para mando	 14.51URE Bandeja transparente rebatible	 14.03MD/S Reposabrazos ajustable	 13.00S Reposabrazos cierre delantero 90°	 21.88 Reposabrazos contención bilateral	 21.40 Soporte palmar
 14.05 Reposabrazos acompañante reclinación (19.98N)	 14.05R Reposabrazos reforzado (19.98N)	 14.78S Reposabrazos abatible ajustable altura (19.98N)	 13.48A Soporte de tronco swing away	 13.48SN Soporte de tronco	 13.67 Almohadas interiores	 14.23 Almohadas interiores salva ropa
 13.58 Abductor	 14.33DE Respaldo dinámico	 14.34EE Respaldo reclinable manual (18.82N)	 14.92S Respaldo reclinable con reposacabezas	 13.22N Basculación eléctrica (18.82N)	 13.22A Contra-basculación eléctrica (18.82N)	 13.27 Elevación eléctrica en altura del asiento
 13.22S Basculación eléctrica (19.98N)	 13.22SA Contra-basculación eléctrica (19.98N)	 13.15SH Respaldo anatómico de fondo en tejido	 13.15SC Respaldo anatómico fondo rígido	 21.06 Apoyo anatómico fijo a la estructura	 21.06B Respaldo anatómico bandas tensoras	 21.06P Respaldo postural superior lateral
 21.06F Placa rígida de respaldo	 13.15SB Asiento anatómico fondo en tejido	 13.15SD Asiento anatómico fondo rígido	 21.18F Placa de asiento rígida	 21.18FP Placa de asiento rígida	 14.74ES Reposapiés de elevación eléctrico	 14.74ESG Reposapiés eléctrico giratorio removible
 14.74N Reposapiés elevador manual	 14.74EPC Reposapiés elevadores manual giratorio desprendible	 14.71DM Reposapiés dinámico	 14.71DTB/DMT Reposapiés dinámico (18.82N/19.98N)	 14.73H Reposapiés doble ajustable ángulo	 14.76 Reposapiés nylon	 14.76H Reposapiés aluminio
 13.12 Trepa paseo	 13.25N Tracción frontal (19.98N)	 13.41N Ruedas antivuelco (18.82N)	 13.43B Ruedas antivuelco (18.82N)	 13.41S2 Ruedas antivuelco tracción frontal (19.98N)	 13.41S1 Ruedas antivuelco tracción trasera (19.98N)	 13.68 Kit luz (18.82N)
 13.05 Soporte bastones	 13.38/14.45ZB Soporte de oxígeno (18.82N/19.98N)	 13.03 Espejo				

EUROPA

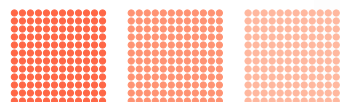

EUROPA, silla de elevación eléctrica y tracción manual. Obtener la posición vertical es mucho más que una capacidad de la silla pero sí un beneficio clínico. La bipedestación permite prevenir múltiples trastornos atribuidos a la inmovilidad, tales como úlceras de decúbito, mala circulación y otras patologías musculoesqueléticas. Su estructura especial permite que estas sillas de incorporación garantizan una reciprocidad de movimientos de la silla con las articulaciones fisiológicas del usuario, permitiendo una bipedestación fluida y suave. Ver accesorios.

EUROPA 18.64M/L 51 CD VT MN EL 42/46

Rueda delantera hinchable	Ø200mm
Rueda trasera hinchable	Ø600mm
Color estructura	azul
Color tapicería	negro
Peso máximo del usuario	120kg
Peso total	38kg

Disponible en España



EUROPA 36	56	36	80-92	64-72	48	36-42	94	70	36-44	90°-102°	75	24
EUROPA 42	59-64	42	90-102	68-78	50	40-55	105	77	40-52	90°-102°	120	38
EUROPA 46	59-64	46	90-102	68-78	50	40-55	105	77	40-52	90°-102°	120	38

EUROPA ACTIVA



EUROPA ACTIVA 18.64LA

51 CD VT GS AT MN 38/40/42/44

Rueda delantera hinchable	Ø100mm
Rueda trasera hinchable	Ø600mm
Color estructura	azul
Color tapicería	negro
Peso máximo del usuario	100kg
Peso Total	21kg

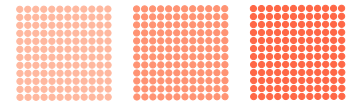

EUROPA ACTIVA 18.64LA, silla de ruedas de bipedestación activa de línea y diseño activo y atractivo. Estructura ligera en duraluminio con acabado brillante. Asiento ajustable en profundidad (8 cm), en altura (de 49 a 55cm) y en ángulo (0° a 12°). Rotación de los reposabrazos hacia arriba y/o hacia atrás, activados por una palanca trasera. Bipedestación por bomba de gas, que permite reducir el esfuerzo físico del usuario al levantarse. Ruedas delanteras y traseras ajustables en altura permitiendo al usuario obtener una óptima estabilidad y equilibrio. Respaldo y asiento acolchados con fajas tensoras. Cinturón torácico. Estabilizadores de rodillas desmontables, regulables en altura y ángulo.



Disponible en España



EUROPA ACTIVA 36	58	36	87-95	72	49-55	30-40	95	78-83	36-52	0°-10°	75	21
EUROPA ACTIVA 38	60	38	87-95	72	49-55	30-40	95	78-83	42-52	0°-10°	100	21
EUROPA ACTIVA 40	62	40	87-95	72	49-55	30-40	95	78-83	42-52	0°-10°	100	21
EUROPA ACTIVA 42	64	42	87-95	72	49-55	30-40	95	78-83	42-52	0°-10°	100	21
EUROPA ACTIVA 44	66	44	87-95	72	49-55	30-40	95	78-83	42-52	0°-10°	100	21

Accesorios & Opciones

					
14.82 Reposacabezas	14.83 Reposacabezas dinámico	14.81A Reposacabezas ajustable	21.82E Reposacabezas occipital	14.81EN Reposacabezas postural fijo	21.80E Reposacabezas occipital envolvente
					
21.78EN Reposacabezas ajustable	21.40 Soporte palmar (18.64M)	14.51URE Bandeja transparente rebatible (18.64M)	13.00S Reposabrazos cierre delantero 90° (18.64M)	14.03MD/S Reposabrazos ajustable (18.64M)	14.78SP Reposabrazos sport (18.64M)
					
14.05A Reposabrazos acompaña reclinación (18.64M)	14.78S Reposabrazos abatible ajustable altura (18.64L/18.64LA)	21.88 Reposabrazos contención bilateral (18.64M)	13.48H Soporte de tronco	13.48A Soporte de tronco swing away	14.23H Almohadas inferiores salva ropa
					
14.78HM Almohadas interiores (18.64L/18.64LA)	14.92L Respaldo eléctrico reclinable completo (18.64M)	14.33DH Respaldo dinámico (18.64M)	14.92G Respaldo reclinable neumático (18.64M)	14.33S2 Respaldo reclinable reposabrazos sport (18.64M)	13.22L Basculación eléctrica (18.64M)
					
13.22G Basculación neumática (18.64M)	13.15SH Respaldo anatómico de fondo en tejido	13.15SC Respaldo anatómico fondo rígido	21.06 Respaldo anatómico fijo a la estructura	21.06B Respaldo anatómico bandas tensoras	21.06P Respaldo postural superior lateral
					
21.06F Placa rígida de respaldo	13.15SB Asiento anatómico fondo en tejido	13.15SD Asiento anatómico fondo rígido	21.18F Placa de asiento rígida	21.18FP Placa de asiento rígida	Apoyo de rodilla regulable
					
14.40H Apoyo de rodilla en T	21.84HC Apoyo de rodilla regulable en T con reposapiés	14.73HM/HE Reposapiés eléctrico (18.64M)	21.84HA Reposapiés en T	14.76 Reposapiés nylon	14.73H Reposapiés doble ajustable ángulo
					
14.71DHE Reposapiés dinámico	14.71DHT Reposapiés dinámico	13.31HE/HM Reposapiés elevadora eléctrica independiente (18.64M)	13.65HM Eje recortado	13.61D/S Mando unilateral (18.64M)	13.70 Cubre radio transparente
					
13.44H Ruedas extras	13.43HM Ruedas antivuelco	13.43B Ruedas antivuelco (18.64M)	13.43GB Ruedas antivuelco	13.43G Ruedas antivuelco (18.64M/18.64L)	13.20 Freno de acompañante



OCEANIA 18.68 E

51 CD VT EL EL 42/46

Rueda delantera hinchable	Ø200mm
Rueda trasera hinchable	Ø320mm
Color estructura	azul, roja
Color tapicería	negro
Potencia	180w
Autonomia	40km
Peso máximo del usuario	120kg
Peso Total	85 a 95kg

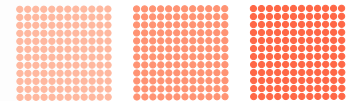

OCEANIA, silla de elevación y tracción eléctrica con capacidad para bipedestación, del asiento de acuerdo con los ejes articulares del usuario. Posibilidad de aplicar basculación eléctrica. Soporte de rodillas ajustable y desmontable. Reposabrazos ajustables. Salva ropa desmontable. Seleccionando más que una opción eléctrica, es necesario la colocación de baterías de 65Ah. Amplia gama de accesorios como opción.



Disponible en España



OCEANIA 36	56	36	80-92	63-68	50	36-42	95	70	36-44	10°	4	100	90°-102°	100	82
OCEANIA 42	60	42	90-102	70-80	50	40-55	105	75	40-52	10°	4	100	90°-102°	120	84
OCEANIA 46	64	46	90-102	70-80	50	40-55	105	75	40-52	10°	4	100	90°-102°	120	84

OCEANIA AVANTI

OCEANIA AVANTI 18.68 A

51 CD VT EL EL TD 42/46

Rueda delantera hinchable	Ø320mm
Rueda trasera hinchable	Ø200mm
Color estructura	roja
Color tapicería	negro
Potencia	180w
Autonomía	35km
Peso máximo del usuario	120kg
Peso Total	110kg

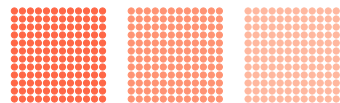

OCEANIA AVANTI 18.68 A, silla de ruedas con tracción y bipedestación eléctricas. Con tracción delantera, facilita las maniobras en espacios reducidos. La combinación entre la robustez y la agilidad de la silla, en sintonía con los ejes articulares del usuario, permiten una bipedestación fluida y suave. Respaldo y asiento acolchados con fajas tensoras. Posibilidad de regular la profundidad (340 + 120mm talla 360, 400 + 120mm tallas 420 y 460) y ancho del asiento (+60mm). Altura de asiento regulable de forma manual desde 450mm hasta 530mm. Respaldo regulable en pendiente (hasta 115°), altura y abatible hacia adelante. Puños ajustables en altura. Estabilizadores de rodillas desmontables, regulables en altura y ángulo. Reposabrazos ajustables en anchura y altura. Protecciones laterales del asiento ajustable en ancho y desmontables. Reposapiés desmontables, regulables en altura. Soporte acolchado para gemelos. Cinturón de contención torácica incluido. Ruedas de tracción delanteras hinchables de 320mm. Ruedas traseras giratorias hinchables de 200mm. Ruedas estabilizadoras debajo de los reposapiés. Autonomía hasta 35km en condiciones normales de piso y peso del usuario. Velocidad máxima de 7 km/h. Con baterías de 42Ah y motores de 180w.



Disponible en España



OCEANIA AVANTI 68 42-46 85-105 70-80 45-52.5 38-50 110 85 38-54 10° 4 120 0°-25° 90°-115° 120 110

OCEANIA VARIO



La silla de ruedas eléctrica OCEANIA VARIO satisface las necesidades prioritarias en el ámbito de la asistencia y atención de pacientes con enfermedades neurológicas y motoras profundas, pues mejora la circulación y funcionamiento del aparato gastrointestinal, reduce el surgimiento de la osteoporosis, mejora el trofismo musculoesquelético, el riesgo de aparición de úlceras de decúbito y de heridas. Está equipada con una estructura muy resistente, con ruedas hinchables, para dar confort en el exterior. El asiento y el respaldo se suministran con cinturones de tensión, revestidos por un tejido elástico acolchado. Las articulaciones siguen simultáneamente los movimientos del usuario, la profundidad y el ancho del asiento son ajustables para adaptarse a las diferentes tallas de los usuarios. Mando articulado de serie.

OCEANIA VARIO 18.70 E

51 CD VT HV 42/46

Rueda delantera hinchable	Ø210mm
Rueda trasera hinchable	Ø380mm
Color estructura	azul / rojo
Color tapicería	negro
Baterías (sin mantenimiento)	65 Ah
Potencia	300w
Peso máximo del usuario	120kg
Peso Total	155kg

Equipamiento de serie:



Elevación del asiento



Horizontalización



Bipedestación



Basculación

Disponible en España



OCEANIA VARIO 36	66	36	80-92	63-68	52-76	36-42	95	93	36-44	+ 16°	4	115	90°-180°	40°	120	100
OCEANIA VARIO 42	66	42	92-102	72-80	52-76	40-50	116	94	40-52	+ 16°	4	115	90°-180°	40°	120	155
OCEANIA VARIO 46	66	46	92-102	72-80	52-76	40-50	116	94	40-52	+ 16°	4	115	90°-180°	40°	120	155

OCEANIA VARIO AVANTI



OCEANIA VARIO AVANTI 18.70A

51 CD VT HV TD 42/46

Rueda delantera neumática	Ø210mm
Rueda trasera neumática	Ø350mm
Color estructura	azul / rojo
Color tapicería	negro
Baterías (sin mantenimiento)	63 Ah
Potencia	350w
Peso máximo del usuario	120kg
Peso Total	155kg

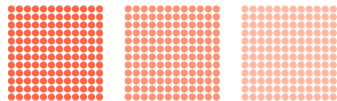

OCEANIA VARIO AVANTI 18.70A es una silla de tracción frontal altamente técnica, proporcionando a su usuario una amplia gama de posiciones. Entre ellas, la posición de bipedestación que proporciona innumerables ventajas en los sistemas circulatorio, musculoesquelético, entre otros. Esta silla beneficia a los más activos pues permite que éstos sean independientes y consigan estar en un nivel más elevado en el trabajo o en la vida social debido no sólo a la bipedestación, sino también a la elevación del asiento hasta 350mm de la medida base. Realiza basculación hasta 40°; reclinación del respaldo hasta 180° (con deslizamiento para reducir las fuerzas de fricción), elevación eléctrica de los reposapiés y horizontalización. Todos los movimientos se realizan en simbiosis con las articulaciones del cuerpo humano. Mando R-NET con pantalla de color. Asiento y respaldo acolchado y anatómico garantiza el máximo confort de su usuario. El asiento es ajustable para adaptarse a la altura del usuario. Reposacabezas ajustables en ángulo, profundidad y altura. Los reposabrazos son ajustable en altura, abatibles y con cierre frontal a 90°. Ruedas de gran talla con suspensión delantera y trasera asegurando un uso más suave y cómodo en pisos menos regulares. Equipada con dos motores de 350W colocados en la delantera, una batería de litio de 63Ah con una autonomía de unos 40km y cargador para baterías de litio. La carga de las baterías es bastante rápida, tardando sólo dos horas, siendo una plusvalía para los usuarios activos. Velocidad máxima de 10Km/h. Kit de luces incluido de serie.











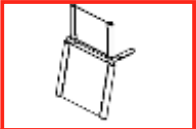

















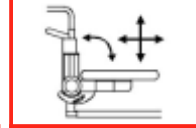

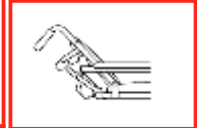









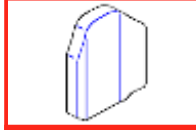
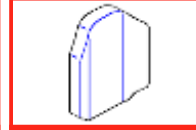







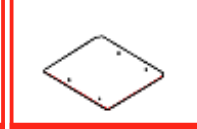



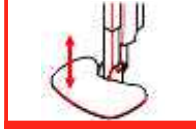





Disponible en España



OCEANIA VARIO AVANTI 36	66	36	80-92	63-68	52-76	36-42	102	94	36-44	12°	4	115	40°	90°-180°	100	155
OCEANIA VARIO AVANTI 42	66	42-46	92-102	72-80	52-76	40-50	116	94	40-52	12°	4	115	40°	90°-180°	120	155

Accesorios & Opciones

						
14.82 Reposacabezas	14.83 Reposacabezas dinámico	14.81A Reposacabezas ajustable	21.82E Reposacabezas occipital	14.81EN Reposacabezas postural fijo	21.80E Reposacabezas occipital envolvente	21.78EN Reposacabezas ajustable
						
14.98R Mando mentoniano	14.99 Mando mentoniano	14.95 Mando doble	14.94U Mando de acompañante	13.26C Mando abatible (18.68E)	13.11 Protección de mando	21.40 Soporte palmar
						
14.96 Bandeja rebatible c/ mando fijo	14.96S Bandeja rebatible c/ mandorebatible	14.51URE Bandeja transparente rebatible	13.00S Reposabrazos cierre delantero 90°	14.03MD/S Reposabrazos ajustable	14.78SP Reposabrazos sport (18.68E)	14.05A Reposabrazos acompaña reclinación (18.68E)
						
21.88 Reposabrazos contención bilateral	13.48H Soporte de tronco	13.48A Soporte de tronco swing away	13.67 Almohadas interiores (18.70)	14.23H Almohadas interiores salva ropa	14.92L Respaldo eléctrico reclinable completo (18.68E)	14.33DH Respaldo dinámico (18.68E)
						
14.92G Respaldo reclinable neumático (18.68E)	14.33S2 Respaldo reclinable apoyabrazos sport (18.68E)	13.22L Basculación eléctrica (18.68E)	13.15SH Respaldo anatómico de fondo en tejido	13.15SC Respaldo anatómico fondo rígido	21.06 Respaldo anatómico fijo a la estructura	21.06B Respaldo anatómico bandas tensoras
						
21.06P Respaldo postural superior lateral	21.06F Placa rígida de respaldo	13.15SB Asiento anatómico fondo en tejido	13.15SD Asiento anatómico fondo rígido	21.18F Placa de asiento rígida	21.18FP Placa de asiento rígida	13.42 Apoyo de rodilla regulable
						
14.40H Apoyo de rodilla en T	14.41 Apoyo de rodilla independientes (18.70)	21.84HC Apoyo de rodilla regulable en T con reposapiés	14.73HM/HE Reposapiés eléctrico (18.68E)	21.84HA Reposapiés en T	14.76 Reposapiés nylon	14.73H Reposapiés doble ajustable ángulo
						
14.71DHE Reposapiés dinámico	14.71DHT Reposapiés dinámico	13.31HE/HM Reposapiés elevadora eléctrica independiente (18.68E)	13.31HV Reposapiés elevadora eléctrica (18.70)	14.74HV Reposapiés eléctrica independiente (18.70)	14.73VT Reposapiés elevadora manual independiente	13.43B Ruedas antivuelco (18.68E)
						
13.41N Ruedas antivuelco (18.68E)	13.12HV Rueda sobre escaleras (18.70)	13.68H Kit luz	13.03 Espejo			

INCA | INCA PLUS



51 CD EL IN 49 AP



51 CD EL IP 43 AP

INCA | INCA PLUS

51 CD EL 2 IN 49 AP | 51 CD EL 2 IP 43 AP

Ruedas delanteras - hinchables Front wheels - pneumatic	Ø175mm Ø175mm
Ruedas traseras - hinchables Back wheels - pneumatic	Ø200mm Ø300mm
Color de la estructura Structure's colour	gris grey
Dimensiones Dimensions	34x66x75cm 40x62x78cm
Asiento Seat	38cm 48cm
Velocidad máxima hacia adelante Maximum speed forward	6km/h*
Velocidad máxima hacia atrás Maximum reverse speed	3km/h*
Motores directos Engines	180W 250W
Baterías de litio (2) Lithium batteries	10Ah 12Ah
Radio de giro Turning radius	115cm 96cm
Máxima pendiente Max. driving slope	12°
Autonomía Autonomy	15km
Peso total Total weight	26,6kg 29,6kg
Peso máximo de usuario Maximum user weight	115kg 150kg

(*en condiciones normales de suelo y peso de usuario)
(*in normal pavement and user's weight conditions)

INCA, silla eléctrica muy compacta y ligera. Plegable para fácil transporte y almacenamiento. Adecuada para uso en interior y exterior. Con motores directos a las ruedas y 2 baterías de litio incorporadas en la estructura de las patas, ligeras y durables, ofrece tecnología de vanguardia. Muy adecuada para puertas y pasillos estrechos, se transporta con una mano.

INCA, very compact and lightweight electric wheelchair. Foldable for easy transport and storage. Suitable for indoor and outdoor. With motors built into the legs' structure and lithium batteries, light and durable. INCA provides cutting edge technology. Great for tight spaces, narrow corridors and carried with one hand.



INCA
INCA PLUS

66	38	86	51	41	100	42	12°	115	115	26,6
62	48	94	52	49	110	42	12°	96	150	29,6

SCOOTERS



LIBERTY 51 CD SC LI 03/06	
Maxima velocidad Maximum speed	8km/h
Capacidad Capacity	135kg
Dimensiones Dimensions	112x60x87cm
Motor eléctrico Electric motor	200w
Autonomia Autonomy	20km
Baterías Batteries	2x12V 22Ah
Asiento ligero y rebatible Lightweight folding seat	46cm
Colores Colours	

ECO 51 CD SC EC 03/06	
Maxima velocidad Maximum speed	8km/h
Capacidad Capacity	135kg
Dimensiones Dimensions	116x55x87cm
Motor eléctrico Electric motor	450w
Autonomia Autonomy	20km
Baterías Batteries	2x12V 35Ah
Asiento ligero y rebatible Lightweight folding seat	46cm
Colores Colours	

COMPACT DELUXE 51 CD SC CD 03/06	
Velocidade máxima Maximum speed	8 km/h
Capacidade Capacity	160kg
Dimensiones Dimensions	134x62x100cm
Motor eléctrico Electric motor	500w
Autonomia Autonomy	40km
Baterías Batteries	2x12V 45Ah
Asiento ajustable y reclinable de lujo Adjustable and reclining luxury seat	48cm
Suspensión trasera «coil over» Rear suspension coil over	
Manillar en delta Delta handle	
Colores Colours	



EXTRA 51 CD SC EX 03/06	
Velocidad máxima Maximum speed	12km/h
Capacidad Capacity	180kg
Dimensiones Dimensions	139x67,5x102,4cm
Motor eléctrico Electric motor	700w
Autonomia Autonomy	40km
Baterías Batteries	2x12V 45Ah
Asiento ajustable e reclinable de lujo Adjustable and reclining luxury seat	48cm
Suspensão frontal e traseira Front and rear suspension	
Manillar en delta anti-fatiga Anti-fatigue delta handle	
Limitador de velocidad y freno manual Speed limiter and handbrake	
Colores Colours	

XXL 51 CD SC XXL 03/06	
Velocidade máxima Maximum speed	15Km/h
Capacidade Capacity	226kg
Dimensiones Dimensions	163x76x103cm
Motor eléctrico Electric motor	800W 4300rpm
Autonomia Autonomy	50km
Baterías Batteries	2x12V 80/100Ah
Asiento ajustable y reclinable de lujo Adjustable and reclining luxury seat	46cm
Suspensión frontal y trasera Front and rear suspension	
Manillar delta Delta handle	
Colores Colours	

OTRAS SOLUCIONES OTHER SOLUTIONS

MAIA



Colores disponibles:
Available colours:



MAIA, silla de ruedas en acero para hospital/institución con diseño innovador y avanzado. Robusta, con 2 colores disponibles, es apilable frontalmente, para mayor comodidad y velocidad. Reposabrazos plegables. Su asiento está suspendido elásticamente con inclinación ergonómica (9°) del asiento y del respaldo. Puños ergonómicos. Funda extraíble y lavable para facilitar su substitución. Reposapiés único (opción). Accesorios: soportes de botella de oxígeno e intravenoso, torre de apilamiento, monedero cinturón. Ruedas traseras de Ø600mm o Ø300mm.

51 CD IZ 2 NO L BX

MAIA, steel wheelchair for hospital/institutions with innovative and advanced design. Robust, available in 2 colours, with easy frontal storage, for convenience and speed. Folding armrests. Elastically suspended seat with 9° ergonomic inclination on seat and backrest. Ergonomic handles. Removable, washable cover for easy replacement. One-piece metal footrest (option). Accessories: oxygen bottle holder, IV pole, stacking tower, coin holder, belt. Ø600mm or Ø300mm back wheels.

MAIA MAIA AE	68 65	43 43	9° 9°	105 105	72 72	53 53	45 45	105 95	84 71	46 46	180 180	13.9 12.4

AVIÓN PLANE



Silla de ruedas para cabina de avión con estructura en acero recubierta a epoxy en color gris metalizado. Reposacabezas regulable en altura y reposabrazos abatibles. Tapizado con espuma de alta densidad, revestimiento lavable y desinfectable. Con freno central y cinturones de seguridad. Los puños superiores son plegables y los inferiores son abatibles. Con 4 ruedas macizas Ø200mm y 2 pequeños rodillos. Para usuarios hasta 180kg.

Wheelchair for airplane cabin with steel structure epoxy coated metallic grey. Height adjustable headrest and foldable armrests. Upholstery with high density coating, washable and disinfected. Central brake and security seat belts. The top handles are foldable and the bottom are collapsible. With 4 solid Ø200mm wheels and 2 small castors. Maximum user's weight up to 180kg.



51 CD CA 2 DD

AVIÓN / PLANE	43 31	94 69	43 45	80 35	180

(puño / handle)
100
(apoyo de cabeza / headrest)

MOTOR AUXILIAR AUXILIAR ENGINE

El kit PowerStroll es un sistema de motorización auxiliar diseñado para incorporar a sillas de ruedas manuales y convertirlas en sillas eléctricas. Con el Powerstroll, el asistente no hace esfuerzo para impulsar la silla.

El motor se coloca en la parte posterior de la silla y tiene un mando de control colocado en la empuñadura de la silla para operar el motor. Permite el cambio de sentido (hacia adelante y marcha atrás) a través de un botón situado en el soporte de las baterías y el control de velocidad a través de un botón giratorio situado en el mando. Tiene un indicador de nivel de batería para saber cuándo cargar las baterías y que nunca le falle la energía para ir más allá.

Fácil instalación, compatible con una gran variedad de sillas con ruedas traseras 300 mm y 600 mm. Con una cómoda bolsa para transporte.

Disponible en dos modelos:

Motor Auxiliar - 150W

Motor Auxiliar Plus - 200W

PowerStroll kit is a motorized system designed to incorporate in manual wheelchairs and transform them into power chairs. With Powerstroll, the assistant makes no effort to push the wheelchair.

The engine is placed in the back of the chair and has a control command to place on the handle of the wheelchair to operate the engine. Allows to change the direction (forward and reverse) by a button on the battery holder and the speed control via a rotary knob on the remote. It has a battery level indicator so you know when to charge the batteries and power never fails to go beyond.

Easy installation, compatible with a wide variety of wheelchairs with rear wheels 300 mm and 600 mm. With a convenient transport bag.

Available in two models:

Auxiliar Engine - 150W

Auxiliar Engine Plus - 200W



MOTOR AUXILIAR AUXILIAR ENGINE 51 MT AU / 51 MT AU PL

Dimensiones de conjunto ruedas y baterías Wheel and bateries dimensions	32x26cm
Alto (con baterías incorporadas) Height (with bateries inco)	37cm
Ruedas neumáticas Pneumatic wheels	Ø200mm
Motor Engine	150W o 200W (version Plus); 24V 150W or 200W (version Plus); 24V
Baterías Bateries	12Ah; 2x12V
Autonomía Autonomy	16km*
Velocidad máxima Maximum speed	6,4km/h*
Controlador Controler	PG-S-Drive 45A
Color Colour	negro / black
Peso sin baterías Weight without batteries	11,9kg
Peso de las baterías Bateries weight	9,3kg
Peso máximo (usuario y silla) Maximum weight (user and wheelchair)	135kg

(*en condiciones normales de suelo y usuario)
(* in normal pavement and user's conditions)

Bolsa de transporte
Transport bag



Ajustable al silla
Wheelchair adjustable



Mando de control
Control command



Bolsa para baterías
Bateries' bag



Indicador nivel de batería
Battery level indicator



Modo manual
Manual mode



SILLAS DE INTERIOR INTERIOR WHEELCHAIRS



COMMODE

Silla de interior con asiento de sanitario.
Asiento sanitario con tapa acolchada,
en PVC lavable.
Altura ajustable en 7 posiciones.

Indoor chair with sanitary seat. PVC
padded seat.
Height adjustable chair in 7 positions.



51 CD IN 4 CO FX

COMMODE 51 CD IN 4 CO FX

Color	azul
Colour	blue
Tapicería confort	PVC azul
Confort upholstery	blue PVC
Peso total	8kg
Total weight	
Peso máximo del usuario	100kg
Maximum user weight	



COMMODE 56 83,2-94,5 41 52 42,5 44 100 8

COMFORT LIGHT

COMFORTLIGHT REGULABLE EN ALTURA HEIGHT ADJUSTABLE 51 CD IN W AL 46 ZZ

Color	anodizado champán
Colour	anodized champagne
Asiento	sanitario anatómico
Seat	anatomic sanitary
Regulable en altura	
Height adjustable	
Peso total	7kg
Total weight	
Peso máximo del usuario	100kg
Maximum user weight	



51 CD IN W AL 46 RR

Concebidas para dar al usuario la
posibilidad de usufruir de una
comoda silla de estar con la
función sanitaria. Con o sin
rodeznos, con asiento sanitario
anatómico, talla 46.

Conceived to offer the user a
comfortable interior chair with WC
function. With or without
casters, with anatomic sanitary
seat, size 46.

COMFORTLIGHT FIJA 4 RODEZNOS FIX 4 CASTERS 51 CD IN W AL 46 ZZ

Color	anodizado champán
Colour	anodized champagne
Asiento	sanitario anatómico
Seat	anatomic sanitary
Con 4 rodeznos (dos con freno)	
4 caster wheels (two with brakes)	
Peso total	7,8kg
Total weight	
Peso máximo del usuario	100kg
Maximum user's weight	



51 CD IN W AL 46 ZZ



COMFORT LIGHT REG ALT/HEIGHT ADJUST. 54 46 89/99 70/80 52/62 44 58 49 100 7
COMFORT LIGHT 4 RODEZNOS/CASTERS 54 46 93 74 56 44 59 49 100 7,8

ANDALUS FIJA FIX



51 CD IN 2 AN 46 RR FX

ANDALUS FIJA FIX 51 CD IN 2 AN 46 RR FX	
Color Colour	ceniza metalizado metallic grey
Asiento sanitario anatómico Anatomic sanitary seat	
Peso sin componentes desmontables Weight without removable parts	8,8kg
Peso total Total weight	14,2kg
Peso máximo del usuario Maximum user weight	100kg

ANDALUS FIJA, con estructura en acero y asiento anatómico sanitario. Silla de interior que permite el uso sanitario directamente o en el cuarto de baño y mantiene la comodidad del usuario. Asiento blando termomoldeado anatómico, con 46cm de ancho, reposapiés desmontables, de apertura lateral y regulables en altura.

ANDALUS FIX, with a steel structure and anatomic sanitary seat. ANDALUS joins 4 functions in one: the comfort of an interior chair that allows the sanitary use, directly or in the WC and maintains user's comfort. 46cm width thermomolding soft seat and dettachable feet rest with side opening and height adjustable.



ANDALUS FIJA / FIX

56 46 91 74 54 34 94 42 100 14,2

ANDALUS PLEGABLE FOLDABLE



51 CD IN 2 AN 46 RR AR

Con estructura en acero, asiento anatómico y 4 rodesnos de Ø100mm, ANDALUS reúne 4 funciones en una silla: el confort de una silla de interior, permite el uso sanitario directamente na silla o en el cuarto de baño y es plegable para facilitar su transporte. Asiento blando termomoldeado anatómico, talla 46. Reposapiés desmontables y regulables en altura.

With a steel structure, anatomic seat and four Ø100mm castors, ANDALUS joins 4 functions in one: the comfort of an interior chair that allows the sanitary use, directly or in the WC and it is foldable to ease its transport. 46cm width thermomolding soft seat. Removable and height adjustable footrest. and dettachable and height adjustable feet rest.



Facilmente desmontable Easily detachable	
ANDALUS PLEGABLE FOLDABLE 51 CD IN 2 AN 46 RR AR	
4 rodesnos 4 casters	Ø100mm
Color Colour	ceniza metalizado metallic grey
Asiento sanitario anatómico Anatomic sanitary seat	
Peso sin componentes desmontables Weight without removable parts	9,4kg
Peso total Total weight	14,6kg
Peso máximo del usuario Maximum user weight	100kg



ANDALUS PLEGABLE / FOLDABLE

56 46 22 91 74 54 34 94 42 100 14,6

ANDALUS RECLINE



51 CD IN 2 AN 46 RR RC

Facilmente desmontable
Easily detachable

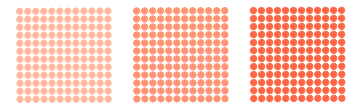

Reposabrazos
Armrests



Cubo
Bucket



Reposapiés
Footrests



Rodeznos Ø100mm
Ø100mm castors



ANDALUS RECLINE

51 CD IN 2 AN 46 RR RC

4 rodeznos 4 casters	Ø100mm
Asiento sanitario anatómico Anatomic sanitary seat	
Reclinación Reclining	120°
Color Colour	ceniza metalizado metallic grey
Peso sin componentes desmontables Weight without removable parts	12,2kg
Peso total Total weight	19,6kg
Peso máximo del usuario Maximum user weight	100kg

ANDALUS RECLINE, estructura en acero y asiento blando en termomoldeado anatómico, talla 46. Respaldo rígido con 2 fajas lumbares, almohadillado con funda en sky, muy confortable e fácil de limpiar. Con reclinación mecánica 120°. Reposabrazos regulables en altura. Reposapiés con apertura lateral. 4 rodeznos de Ø100mm. También disponible modelo con ruedas traseras de Ø300mm.

ANDALUS RECLINE, steel structure and 46cm width thermomolding soft seat. Paded rigid backrest with 2 tensioning straps, sky cover, very comfortable and easy to clean. 120° mechanical recline. Height adjustable armrests. Side opening footrests. Ø100mm front wheels and rear casters. Also available model with Ø300mm back wheels.



ANDALUS RECLINE Ø100MM
ANDALUS RECLINE Ø300MM

57
63

46
46

116-121
116-121

69-74
69-74

52
52

46
46

92
92

68
68

44
44

120°
120°

100
100

19,6
22,6

kg

COMFORT PLUS

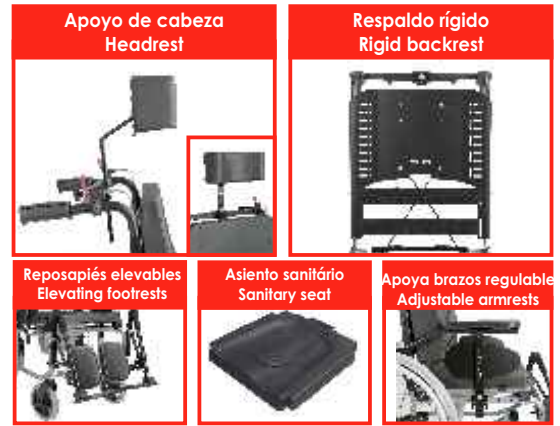

51 CD IN 2 CP 46 ED

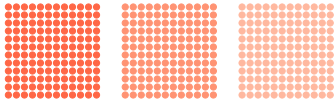

COMFORT PLUS 51 CD IN 2 CP 46 ED

Ruedas delanteras - macizas Front wheels - solid	Ø200mm
2 rodesnos 2 casters	Ø50mm
Ruedas traseras Back wheels	Ø300mm / Ø600mm
Llantas Rims	rayadas spokes
Reclinación Reclining	120°
Color Colour	ceniza metalizada metallic grey
Asiento sanitario anatómico Anatomic sanitary seat	
Peso sin componentes desmontables Weight without removable parts	9,4kg
Peso total Total weight	18kg
Peso máximo del usuario Maximum user weight	100kg

COMFORT PLUS combina las ventajas de una silla cama y una cómoda silla con posibilidad de utilización directa en los aseos. De elevado confort, con asiento sanitario anatómico, respaldo rígido con dos fajas lumbares de tensión. Reposacabezas en U ajustable en altura. Permite la reclinación del respaldo y la elevación de los reposapiés. Reposabrazos destacables para facilitar el traslado. Estructura en acero con ruedas traseras de Ø600mm con eje de extracción y dos rodesnos, ruedas delanteras de Ø200mm, proporcionando el uso en espacios angostos.

COMFORTPLUS combines the advantages of bed and chair wheelchair with possibility of direct use of the toilet. High comfort, with anatomic sanitary seat, rigid backrest with two tensioning straps and height adjustable head rest. Reclining back and elevating leg rests. Removable arms for easy access to the user. Steel structure with Ø600mm back wheels, Ø200mm front wheels and two Ø50mm castors in the back providing full stability of the wheelchair.



COMFORTPLUS 46 Ø300MM
COMFORTPLUS 46 Ø600MM

63	46	116-145	61-71	52	46	109-141	82	44	120°	100	20
62	46	116-145	61-71	52	46	117-149	90	44	120°	100	18

ÍNDICE | INDEX

SILLAS MANUALES ACERO MANUAL STEEL WHEELCHAIRS

CELTA COMPACT 3	2
CELTA	3
CELTA EVOLUTION	4
CELTA CAMA/CELTA BED	5
CELTA MANDO Y EJE RETRASADO CELTA COMMAND AND RECOIL	6
PENINSULAR	7
LUSA	8
IBERA	9
ACCESORIOS&OPCIONES ACCESSORIES&OPTIONS	10

SILLAS MANUALES ALUMINIO MANUAL ALUMINUM WHEELCHAIRS

LATINA COMPACT	13
LATINA	14
EXTRALIGHT	15
LATINA ADVANCE	16
ATIVA INVICTUS	17
ACTIVA COMPACT	18
ACTIVA 4LIFE	19
ATIVA SIOUX	20
PROFILE LIGHT	21
ACCESORIOS&OPCIONES ACCESSORIES&OPTIONS	22

SILLAS DE POSICIONAMIENTO POSITIONING WHEELCHAIRS

CARIBE	24
VARIO PLUS	25
CARIBE ADVANCE	26
ACCESORIOS&OPCIONES ACCESSORIES&OPTIONS	28

SILLAS ELÉCTRICAS ELECTRIC WHEELCHAIRS

AZTECA	30
--------	----

EVOLUTION	31
VICKING	32
VICKING ADVANCE	33
VICKING SUSPENSION	34
ACCESORIOS&OPCIONES ACCESSORIES&OPTIONS	35
TILT	36
SPACE	37
4X4	38
ACCESORIOS&OPCIONES ACCESSORIES&OPTIONS	39
EUROPA	40
EUROPA ACTIVA	41
ACCESORIOS&OPCIONES ACCESSORIES&OPTIONS	42
OCEANIA	43
OCEANIA AVANTI	44
OCEANIA VARIO	45
OCEANIA VARIO AVANTI	46
ACCESORIOS&OPCIONES ACCESSORIES&OPTIONS	47
INCA INCA PLUS	48
SCOOTERS	49
OTRAS SOLUCIONES - MAIA / AVIÓN OTHER SOLUTIONS - MAIA / PLANE	50
MOTOR AUXILIAR AUXILIARY MOTOR	51

SILLAS DE INTERIOR INTERIOR WHEELCHAIRS

COMMODE/ COMFORT LIGHT	53
ANDALUS FIJA/FIX ANDALUS PLEGABLE/FOLDABLE	54
ANDALUS RECLINE	55
COMFORT PLUS	56

by **ORTHOS**
XXI
e u r o p e a n
i n c l u s i v e s o l u t i o n s

ORTHOSMAIA XXI

C/ Manuel Nuñez nº2 Ofic.9 Pl. 3 | 36203 Vigo | España
Tel: (+34) 886 312 806 | Móvil: (+34) 678 994 993 | E-mail: comercialespana@orthosxxi.com

ORTHOS XXI, Unipessoal Lda.

Rua de Santa Leocádia | 4809-012 Santa Leocádia de Briteiros | Guimarães | Portugal
Phone: (+351) 253 470 276/ 70/ 74 | Mobile: (+351) 936 199 005
E-mail: margarida.silva@orthosxxi.com | sofia.martins@orthosxxi.com
Fax: (+351) 253 470 278
info@orthosxxi.com
www.orthosxxi.com