



Kapa

Installation Instructions
3D File
Photometry
Revit



PX-0525-ANT

Wall fixture IP54 Kapa LED 8.7W 4000K Urban grey 444lm

TECHNICAL FEATURES



IP54 IK10



Power (W) : 8.7W

Total power consumption of light (W) : 8.7W

Real lumens : 444

Real lm/W : 51

Colour temperature : LED neutral-white 4000K

Lens / reflector angle : HORIZONTAL 109°

Structure material : Aluminium

Structure finish : Urban grey

Diffuser material : Polycarbonate

Diffuser finish : Opal

Useful life : 36.000h L70B30

Equipment included : Yes, electronic

Voltage / frequency : 220-240V/50-60Hz

Warranty : 5 Years

Max. temperature : 25°C

Seaside : No

Energy efficiency : LED A++

LUMINOTECHNIC FEATURES

Light source: LED

CRI: 80

MacAdam steps: 3

Photobiological risk: RG0

UGR

UGR crosswise: 20.6

UGR lengthwise: 14.5

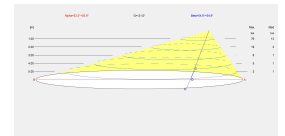
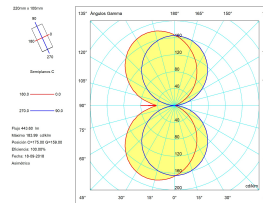

LOGISTICS

Net weight (kg): 0.41

Packaged weight (kg): 0.5



12 Un

LEDS C4[®]

Luminaire

Code PX-0525-ANT
Name KAPA

Measurem.

Code PX-0525-ANT
Name KAPA

Luminaire Flux	443.60 lm	Luminaire Power	10.30 W	Efficacy	43.07 lm/W	Efficiency	100.00%
Sources Flux	443.60 lm	Maximum value	183.99 cd/klm	Position	C=175.00 G=159.00	CG	Asymmetrical
Rectangular Luminaire		Length	220 mm	Width	100 mm	Height	1 mm
Rectangular Luminous Area		Length	210 mm	Width	210 mm	Height	0 mm
Horizontal Luminous Area		0.044100 m ²		Emitting area on Plane 180°		0.000000 m ²	
Emitting area on Plane 0°		0.000000 m ²		Emitting area on Plane 270°		0.000000 m ²	
Emitting area on Plane 90°		0.000000 m ²		Glare area at 76°		0.010669 m ²	
Coordinate system		CG		Symmetry Type		Asymmetrical	
Date		18-09-2018		Maximum Gamma Angle		180	
Measurement Distance		0.00		Measurement Flux		443.60 lm	
Operator		qualitat		Rated Voltage			
Temperature		25.00 °C		Rated Current			
Humidity		60.00 %		Photocell			
Notes							

Line		Code	Luminaire Lamps	Flux [lm]	Pow. [W]	Q.ty
		PX-0525-ANT	Name PX-0468-ANT	443.60	10.30	1
C.I.E.	45 75 92 50 100		D DIN 5040	C31		
F UTE	0.50 E + 0.50 T		B NBN	BZ 5		

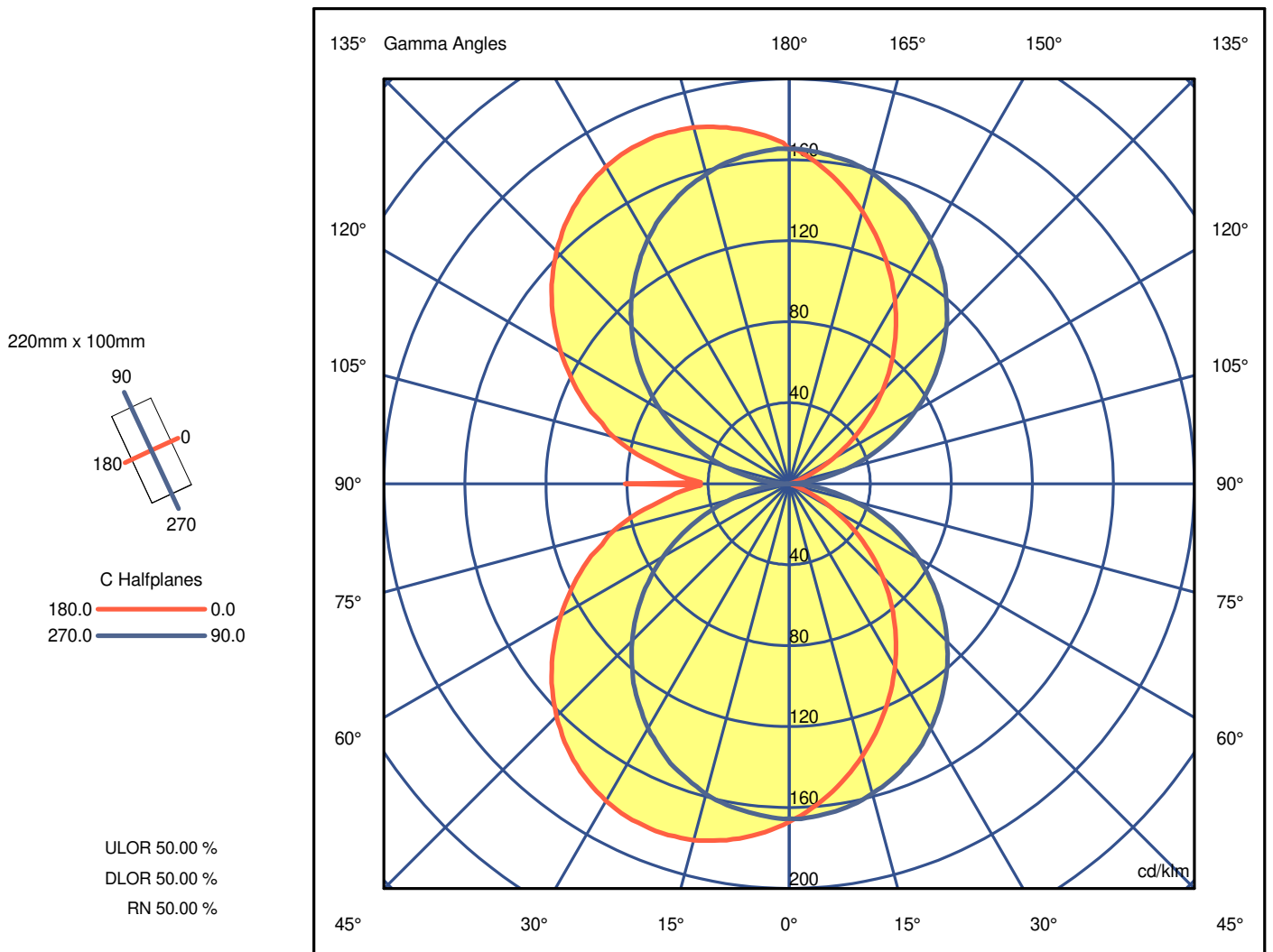

LEDS C4⁺

Luminaire

Code PX-0525-ANT
Name KAPA

Measurerm.

Code PX-0525-ANT
Name KAPA

Luminaire Flux 443.60 lm Luminaire Power 10.30 W Efficacy 43.07 lm/W Efficiency 100.00%

Sources Flux 443.60 lm Maximum value 183.99 cd/klm Position C=175.00 G=159.00 CG Asymmetrical

Luminous Intensity Table cd/klm Table 1/18

	C 0.00	C 5.00	C 10.00	C 15.00	C 20.00	C 25.00	C 30.00	C 35.00	C 40.00	C 45.00	C 50.00	C 55.00	C 60.00
G 0.0	166.94	166.96	166.96	166.95	166.90	166.82	166.72	166.60	166.46	166.29	166.11	166.00	166.04
G 1.0	165.38	165.42	165.45	165.47	165.48	165.49	165.49	165.48	165.46	165.38	165.25	165.17	165.26
G 2.0	164.02	163.97	163.92	163.90	163.90	163.93	163.97	164.01	164.05	164.10	164.17	164.29	164.49
G 3.0	162.35	162.37	162.41	162.49	162.61	162.73	162.80	162.80	162.77	162.77	162.86	163.09	163.51
G 4.0	160.57	160.57	160.57	160.58	160.75	160.99	161.23	161.43	161.60	161.76	161.96	162.25	162.70
G 5.0	158.98	159.04	159.10	159.17	159.25	159.36	159.51	159.71	159.97	160.26	160.61	161.05	161.64
G 6.0	157.09	157.14	157.18	157.23	157.48	157.79	158.09	158.32	158.55	158.86	159.32	159.92	160.65
G 7.0	155.28	155.31	155.35	155.38	155.70	156.12	156.53	156.87	157.18	157.54	158.01	158.64	159.42
G 8.0	153.49	153.56	153.62	153.69	153.97	154.34	154.74	155.11	155.51	156.02	156.71	157.53	158.44
G 9.0	151.51	151.54	151.63	151.84	152.21	152.66	153.12	153.52	153.93	154.46	155.18	156.09	157.11
G 10.0	149.56	149.61	149.69	149.84	150.10	150.47	150.96	151.58	152.30	153.10	153.96	154.90	155.95
G 11.0	147.55	147.70	147.86	148.06	148.32	148.66	149.13	149.74	150.50	151.37	152.34	153.41	154.56
G 12.0	145.62	145.73	145.84	145.95	146.39	146.94	147.54	148.10	148.72	149.52	150.57	151.81	153.16
G 13.0	143.34	143.39	143.53	143.81	144.29	144.92	145.61	146.30	147.06	147.97	149.10	150.40	151.78
G 14.0	141.28	141.37	141.54	141.85	142.36	143.01	143.75	144.51	145.34	146.30	147.45	148.77	150.20
G 15.0	139.22	139.35	139.55	139.87	140.37	141.01	141.72	142.49	143.36	144.40	145.68	147.14	148.73
G 16.0	136.94	137.00	137.16	137.52	138.16	138.98	139.86	140.71	141.61	142.69	144.04	145.60	147.28
G 17.0	134.85	134.96	135.14	135.48	136.03	136.76	137.61	138.53	139.59	140.82	142.28	143.91	145.64
G 18.0	132.65	132.68	132.84	133.23	133.94	134.86	135.85	136.79	137.78	138.97	140.44	142.14	143.95
G 19.0	130.37	130.52	130.68	130.84	131.57	132.55	133.64	134.75	135.91	137.23	138.76	140.48	142.32
G 20.0	128.15	128.23	128.41	128.80	129.47	130.35	131.38	132.47	133.70	135.13	136.82	138.69	140.65
G 21.0	125.81	125.87	126.06	126.50	127.27	128.27	129.36	130.44	131.61	133.01	134.74	136.71	138.78
G 22.0	123.46	123.52	123.70	124.14	124.93	125.96	127.10	128.27	129.54	131.04	132.84	134.88	137.04
G 23.0	121.22	121.34	121.56	121.99	122.69	123.62	124.72	125.95	127.34	128.97	130.86	132.96	135.15
G 24.0	118.82	118.91	119.12	119.59	120.39	121.44	122.63	123.87	125.23	126.83	128.74	130.90	133.19
G 25.0	116.44	116.53	116.76	117.25	118.10	119.20	120.43	121.69	123.08	124.75	126.79	129.09	131.46
G 26.0	114.16	114.22	114.43	114.90	115.74	116.86	118.11	119.42	120.88	122.63	124.74	127.11	129.55
G 27.0	111.72	111.87	112.14	112.66	113.52	114.62	115.87	117.19	118.66	120.44	122.60	125.01	127.52
G 28.0	109.15	109.19	109.39	109.91	110.85	112.11	113.52	114.98	116.57	118.40	120.56	122.97	125.52
G 29.0	106.79	106.94	107.21	107.72	108.57	109.71	111.04	112.51	114.18	116.12	118.38	120.88	123.50
G 30.0	104.37	104.47	104.71	105.24	106.14	107.35	108.73	110.21	111.87	113.83	116.15	118.74	121.42
G 31.0	101.78	101.84	102.07	102.63	103.63	104.95	106.43	107.94	109.59	111.55	113.93	116.59	119.35
G 32.0	99.24	99.39	99.68	100.26	101.22	102.49	103.97	105.56	107.34	109.40	111.83	114.51	117.30
G 33.0	96.74	96.87	97.15	97.74	98.73	100.05	101.53	103.10	104.85	106.91	109.37	112.12	114.97
G 34.0	94.10	94.23	94.51	95.14	96.22	97.63	99.20	100.82	102.60	104.71	107.25	110.08	112.99
G 35.0	91.59	91.73	92.04	92.66	93.70	95.08	96.64	98.29	100.12	102.28	104.85	107.71	110.68
G 36.0	89.07	89.15	89.41	90.02	91.11	92.55	94.19	95.89	97.75	99.93	102.52	105.39	108.39
G 37.0	86.38	86.52	86.83	87.48	88.58	90.04	91.68	93.40	95.29	97.51	100.15	103.09	106.15
G 38.0	83.72	83.89	84.23	84.89	86.00	87.44	89.09	90.82	92.76	95.04	97.75	100.78	103.93
G 39.0	81.35	81.45	81.72	82.32	83.37	84.80	86.47	88.31	90.35	92.68	95.36	98.30	101.41
G 40.0	78.65	78.74	79.01	79.66	80.81	82.34	84.06	85.84	87.81	90.14	92.94	96.06	99.29
G 41.0	75.90	76.02	76.32	77.00	78.17	79.71	81.47	83.30	85.33	87.71	90.55	93.69	96.94
G 42.0	73.25	73.35	73.64	74.32	75.51	77.08	78.86	80.71	82.74	85.11	87.93	91.07	94.35
G 43.0	70.54	70.70	71.04	71.74	72.93	74.50	76.28	78.15	80.23	82.66	85.54	88.74	92.05
G 44.0	67.78	67.92	68.25	68.97	70.20	71.83	73.67	75.59	77.70	80.15	83.04	86.26	89.63
G 45.0	65.15	65.29	65.62	66.32	67.53	69.14	70.98	72.95	75.12	77.62	80.51	83.71	87.08
G 46.0	62.34	62.54	62.92	63.67	64.91	66.54	68.39	70.33	72.48	74.98	77.93	81.20	84.62
G 47.0	59.60	59.77	60.14	60.91	62.20	63.89	65.78	67.76	69.92	72.44	75.43	78.76	82.22
G 48.0	56.93	57.08	57.42	58.15	59.40	61.07	62.99	65.05	67.31	69.90	72.90	76.18	79.60
G 49.0	54.18	54.35	54.72	55.49	56.78	58.48	60.40	62.41	64.62	67.20	70.24	73.61	77.11
G 50.0	51.40	51.57	51.94	52.72	54.03	55.76	57.72	59.77	62.01	64.61	67.66	71.03	74.55
G 51.0	48.69	48.84	49.19	49.96	51.29	53.04	55.02	57.10	59.38	62.03	65.13	68.55	72.09
G 52.0	45.92	46.10	46.48	47.26	48.58	50.33	52.31	54.39	56.68	59.33	62.43	65.86	69.43
G 53.0	43.15	43.31	43.69	44.49	45.85	47.63	49.63	51.70	53.96	56.59	59.73	63.21	66.84
G 54.0	40.48	40.64	41.00	41.77	43.10	44.85	46.87	49.01	51.36	54.07	57.20	60.65	64.24
G 55.0	37.80	37.98	38.36	39.14	40.46	42.20	44.19	46.30	48.62	51.30	54.45	57.92	61.54
G 56.0	35.05	35.21	35.58	36.38	37.74	39.53	41.55	43.64	45.93	48.60	51.75	55.25	58.93
G 57.0	32.37	32.53	32.89	33.68	35.03	36.82	38.86	41.00	43.34	46.01	49.12	52.55	56.16
G 58.0	29.80	29.94	30.30	31.09	32.45	34.24	36.24	38.31	40.56	43.18	46.28	49.76	53.42
G 59.0	27.12	27.31	27.70	28.50	29.85	31.62	33.61	35.70	37.96	40.57	43.63	47.03	50.66
G 60.0	24.63	24.79	25.15	25.92	27.24	28.98	30.97	33.06	35.34	37.95	40.96	44.32	47.90
G 61.0	22.14	22.30	22.67	23.44	24.75	26.45	28.37	30.36	32.53	35.06	38.07	41.47	45.09
G 62.0	19.63	19.80	20.18	20.95	22.26	23.96	25.86	27.81	29.93	32.42	35.39	38.76	42.39
G 63.0	17.22	17.38	17.73	18.49	19.79	21.47	23.34	25.25	27.33	29.77	32.71	36.07	39.69
G 64.0	14.96	15.13	15.49	16.23	17.47	19.08	20.84	22.63	24.60	26.99	29.94	33.34	37.00
G 65.0	12.71	12.87	13.22	13.95	15.18	16.77	18.47	20.15	22.00	24.31	27.26	30.71	34.41
G 66.0	10.57	10.73	11.06	11.76	12.94	14.44	16.07	17.68	19.48	21.75	24.68	28.10	31.78
G 67.0	8.62	8.78	9.10	9.75	10.84	12.23	13.73	15.24	16.95	19.17	22.08	25.50	29.15
G 68.0	6.71	6.86	7.18	7.80	8.84	10.15	11.56	12.96	14.58	16.71	19.57	22.95	26.59
G 69.0	4.92	5.09	5.39	5.95	6.88	8.06	9.37	10.73	12.33	14.45	17.26	20.58	24.14
G 70.0	3.34	3.58	3.90	4.40	5.14	6.10	7.22	8.48	10.06	12.14	14.88	18.09	21.55
G 71.0	2.36	2.39	2.52	2.84	3.44	4.27	5.28	6.46	7.96	9.97	12.62	15.75	19.14
G 72.0	1.37	1.48	1.62	1.83	2.16	2.66	3.41	4.48	5.96	7.97	10.54	13.55	16.81

LEDS C4⁺

Luminaire

Code PX-0525-ANT
Name KAPA

Measurement

Code PX-0525-ANT
Name KAPA

Luminaire Flux	443.60 lm	Luminaire Power	10.30 W	Efficacy	43.07 lm/W	Efficiency	100.00%
Sources Flux	443.60 lm	Maximum value	183.99 cd/klm	Position	C=175.00 G=159.00	CG	Asymmetrical

Luminous Intensity Table cd/klm Table 2/18

	C 65.00	C 70.00	C 75.00	C 80.00	C 85.00	C 90.00	C 95.00	C 100.00	C 105.00	C 110.00	C 115.00	C 120.00	C 125.00
G 0.0	166.29	166.56	166.65	166.38	165.91	165.44	165.14	165.02	165.04	165.14	165.28	165.38	165.37
G 1.0	165.58	165.97	166.20	166.12	165.83	165.51	165.32	165.29	165.43	165.73	166.08	166.35	166.36
G 2.0	164.81	165.15	165.44	165.51	165.59	165.66	165.72	165.78	165.84	166.09	166.39	166.69	166.93
G 3.0	164.11	164.72	165.14	165.23	165.14	165.13	165.36	165.77	166.23	166.63	166.98	167.29	167.58
G 4.0	163.32	163.98	164.48	164.71	164.78	164.88	165.14	165.57	166.14	166.82	167.51	168.11	168.54
G 5.0	162.40	163.17	163.76	164.07	164.25	164.53	165.09	165.82	166.57	167.21	167.76	168.27	168.80
G 6.0	161.46	162.27	162.94	163.40	163.76	164.17	164.73	165.43	166.22	167.03	167.84	168.63	169.37
G 7.0	160.36	161.32	162.17	162.79	163.29	163.82	164.50	165.32	166.26	167.28	168.28	169.16	169.86
G 8.0	159.38	160.30	161.16	161.93	162.67	163.48	164.41	165.41	166.40	167.34	168.23	169.15	170.10
G 9.0	158.22	159.32	160.34	161.23	162.04	162.88	163.82	164.86	166.01	167.24	168.48	169.63	170.61
G 10.0	157.10	158.28	159.40	160.39	161.31	162.26	163.31	164.51	165.86	167.34	168.82	170.12	171.12
G 11.0	155.80	157.05	158.27	159.40	160.53	161.73	163.07	164.49	165.89	167.21	168.47	169.69	170.92
G 12.0	154.52	155.88	157.22	158.53	159.83	161.11	162.40	163.75	165.22	166.84	168.51	170.06	171.38
G 13.0	153.19	154.59	155.99	157.39	158.80	160.26	161.80	163.40	165.06	166.76	168.42	169.95	171.29
G 14.0	151.72	153.27	154.80	156.28	157.76	159.32	161.01	162.79	164.60	166.38	168.12	169.78	171.34
G 15.0	150.37	152.01	153.61	155.14	156.68	158.34	160.18	162.15	164.14	166.07	167.90	169.62	171.23
G 16.0	149.01	150.74	152.42	154.03	155.65	157.40	159.33	161.40	163.51	165.57	167.54	169.39	171.10
G 17.0	147.41	149.21	151.02	152.85	154.72	156.64	158.63	160.68	162.75	164.82	166.88	168.89	170.83
G 18.0	145.80	147.68	149.59	151.54	153.54	155.58	157.66	159.80	162.02	164.32	166.60	168.71	170.57
G 19.0	144.24	146.23	148.28	150.37	152.50	154.62	156.73	158.87	161.12	163.50	165.92	168.22	170.29
G 20.0	142.62	144.63	146.71	148.91	151.20	153.51	155.83	158.16	160.54	162.97	165.42	167.79	170.03
G 21.0	140.85	142.95	145.14	147.48	149.92	152.37	154.80	157.23	159.69	162.22	164.73	167.15	169.39
G 22.0	139.23	141.45	143.73	146.08	148.49	150.98	153.52	156.12	158.76	161.42	164.05	166.55	168.88
G 23.0	137.36	139.63	142.02	144.56	147.21	149.89	152.54	155.17	157.81	160.48	163.13	165.72	168.18
G 24.0	135.55	137.96	140.45	143.03	145.67	148.34	151.03	153.77	156.59	159.52	162.46	165.27	167.87
G 25.0	133.78	136.12	138.63	141.38	144.28	147.18	149.98	152.74	155.60	158.61	161.64	164.51	167.07
G 26.0	131.92	134.34	136.94	139.81	142.85	145.87	148.76	151.59	154.48	157.50	160.56	163.53	166.29
G 27.0	129.98	132.50	135.22	138.21	141.35	144.49	147.47	150.40	153.38	156.49	159.63	162.63	165.37
G 28.0	128.13	130.81	133.60	136.54	139.57	142.65	145.72	148.82	152.01	155.28	158.52	161.60	164.40
G 29.0	126.14	128.85	131.69	134.72	137.87	141.05	144.21	147.38	150.62	153.95	157.28	160.47	163.43
G 30.0	124.08	126.81	129.75	132.97	136.33	139.63	142.74	145.80	149.02	152.52	156.12	159.51	162.50
G 31.0	122.08	124.86	127.82	131.04	134.43	137.83	141.13	144.39	147.73	151.19	154.69	158.05	161.16
G 32.0	120.11	122.99	126.02	129.25	132.61	136.00	139.34	142.70	146.18	149.83	153.53	157.09	160.37
G 33.0	117.82	120.73	123.83	127.21	130.76	134.32	137.79	141.23	144.77	148.47	152.18	155.71	158.91
G 34.0	115.84	118.73	121.79	125.13	128.69	132.33	135.97	139.61	143.29	147.01	150.70	154.24	157.55
G 35.0	113.63	116.62	119.79	123.21	126.82	130.50	134.19	137.88	141.63	145.43	149.22	152.87	156.30
G 36.0	111.38	114.44	117.69	121.22	124.92	128.64	132.29	135.95	139.74	143.74	147.76	151.58	155.03
G 37.0	109.19	112.30	115.59	119.15	122.89	126.69	130.45	134.21	138.05	142.01	145.98	149.79	153.33
G 38.0	107.06	110.23	113.56	117.11	120.84	124.64	128.47	132.34	136.34	140.49	144.62	148.53	152.07
G 39.0	104.61	107.93	111.41	115.08	118.91	122.80	126.73	130.68	134.68	138.72	142.71	146.51	150.05
G 40.0	102.49	105.74	109.18	112.91	116.82	120.77	124.66	128.55	132.54	136.69	140.86	144.88	148.63
G 41.0	100.14	103.41	106.92	110.79	114.86	118.92	122.82	126.68	130.68	134.94	139.27	143.40	147.10
G 42.0	97.63	101.01	104.61	108.52	112.62	116.73	120.71	124.68	128.78	133.10	137.44	141.54	145.21
G 43.0	95.34	98.72	102.36	106.34	110.52	114.67	118.64	122.56	126.63	130.97	135.41	139.66	143.54
G 44.0	93.02	96.50	100.16	104.06	108.13	112.24	116.33	120.44	124.68	129.10	133.53	137.75	141.60
G 45.0	90.50	94.03	97.76	101.76	105.93	110.16	114.38	118.62	122.94	127.35	131.72	135.85	139.61
G 46.0	88.04	91.56	95.32	99.40	103.67	107.96	112.14	116.29	120.57	125.03	129.52	133.81	137.71
G 47.0	85.67	89.21	92.97	97.06	101.36	105.72	110.00	114.27	118.63	123.12	127.59	131.83	135.70
G 48.0	83.05	86.63	90.47	94.67	99.06	103.43	107.65	111.82	116.15	120.74	125.39	129.81	133.78
G 49.0	80.60	84.18	88.01	92.18	96.57	100.98	105.26	109.53	113.94	118.58	123.26	127.71	131.72
G 50.0	78.07	81.69	85.56	89.78	94.21	98.66	103.01	107.34	111.77	116.38	121.01	125.41	129.42
G 51.0	75.60	79.20	83.09	87.36	91.87	96.37	100.72	105.01	109.45	114.14	118.85	123.28	127.21
G 52.0	73.01	76.69	80.61	84.87	89.34	93.83	98.22	102.59	107.08	111.76	116.45	120.91	124.98
G 53.0	70.47	74.18	78.14	82.42	86.91	91.42	95.82	100.20	104.73	109.49	114.26	118.76	122.79
G 54.0	67.84	71.56	75.54	79.88	84.41	88.95	93.35	97.74	102.29	107.12	111.98	116.53	120.55
G 55.0	65.16	68.90	72.90	77.28	81.87	86.48	90.96	95.40	99.95	104.71	109.49	114.04	118.16
G 56.0	62.62	66.41	70.41	74.69	79.16	83.71	88.24	92.81	97.50	102.35	107.17	111.74	115.88
G 57.0	59.84	63.65	67.72	72.12	76.71	81.33	85.84	90.35	95.00	99.86	104.72	109.26	113.29
G 58.0	57.15	61.00	65.10	69.52	74.14	78.80	83.38	87.94	92.59	97.36	102.12	106.65	110.79
G 59.0	54.39	58.30	62.48	66.98	71.65	76.29	80.76	85.21	89.83	94.74	99.69	104.34	108.46
G 60.0	51.64	55.58	59.79	64.31	69.00	73.67	78.20	82.69	87.32	92.18	97.06	101.68	105.82
G 61.0	48.83	52.76	57.02	61.64	66.45	71.18	75.68	80.09	84.65	89.53	94.48	99.17	103.37
G 62.0	46.18	50.17	54.42	58.97	63.68	68.36	72.89	77.39	82.05	86.96	91.89	96.55	100.69
G 63.0	43.48	47.47	51.72	56.28	61.00	65.72	70.30	74.84	79.48	84.30	89.12	93.72	97.93
G 64.0	40.77	44.72	48.96	53.54	58.30	63.04	67.59	72.09	76.71	81.56	86.44	91.07	95.25
G 65.0	38.19	42.12	46.31	50.83	55.55	60.27	64.85	69.39	74.05	78.91	83.78	88.40	92.57
G 66.0	35.54	39.43	43.60	48.12	52.84	57.55	62.10	66.61	71.26	76.14	81.05	85.71	89.91
G 67.0	32.84	36.66	40.80	45.37	50.18	54.95	59.51	63.97	68.55	73.39	78.27	82.90	87.09
G 68.0	30.26	34.07	38.19	42.71	47.47	52.21	56.75	61.22	65.81	70.63	75.48	80.08	84.24
G 69.0	27.75	31.50	35.55	40.01	44.70	49.39	53.91	58.38	62.99	67.84	72.73	77.37	81.56
G 70.0	25.08	28.78	32.81	37.25	41.95	46.65	51.20	55.69	60.29	65.10	69.92	74.48	78.58
G 71.0	22.64	26.31	30.30	34.69	39.31	43.94	48.42	52.87	57.45	62.24	67.06	71.63	75.76
G 72.0	20.20	23.79	27.72	32.06	36.63	41.19	45.58	49.94	54.48	59.33	64.26	68.91	73.06

LEDS C4⁺

Luminaire

Code PX-0525-ANT
Name KAPA

Measurement

Code PX-0525-ANT
Name KAPA

Luminaire Flux	443.60 lm	Luminaire Power	10.30 W	Efficacy	43.07 lm/W	Efficiency	100.00%
Sources Flux	443.60 lm	Maximum value	183.99 cd/klm	Position	C=175.00 G=159.00	CG	Asymmetrical

Luminous Intensity Table cd/klm Table 3/18

	C 130.00	C 135.00	C 140.00	C 145.00	C 150.00	C 155.00	C 160.00	C 165.00	C 170.00	C 175.00	C 180.00	C 185.00	C 190.00
G 0.0	165.37	165.36	165.34	165.34	165.33	165.33	165.39	165.62	166.05	166.55	166.94	166.94	166.94
G 1.0	166.38	166.39	166.43	166.48	166.52	166.64	166.84	167.17	167.64	168.14	168.53	168.71	168.71
G 2.0	167.11	167.23	167.32	167.41	167.56	167.81	168.15	168.57	169.03	169.46	169.74	169.81	169.73
G 3.0	167.87	168.15	168.45	168.74	169.02	169.29	169.58	169.95	170.41	170.86	171.18	171.27	171.20
G 4.0	168.84	169.11	169.41	169.72	170.03	170.33	170.66	171.09	171.63	172.17	172.54	172.62	172.48
G 5.0	169.32	169.82	170.29	170.73	171.15	171.56	171.97	172.43	172.91	173.36	173.67	173.77	173.68
G 6.0	170.05	170.66	171.19	171.66	172.06	172.41	172.77	173.21	173.76	174.32	174.74	174.91	174.84
G 7.0	170.46	171.06	171.77	172.49	173.14	173.64	174.05	174.48	174.99	175.49	175.86	176.00	175.94
G 8.0	171.05	171.91	172.64	173.26	173.81	174.32	174.84	175.40	176.02	176.58	176.94	177.01	176.84
G 9.0	171.47	172.28	173.09	173.86	174.54	175.10	175.60	176.12	176.71	177.28	177.71	177.89	177.84
G 10.0	171.92	172.69	173.54	174.44	175.31	176.07	176.75	177.38	177.96	178.46	178.80	178.93	178.84
G 11.0	172.11	173.23	174.25	175.17	176.01	176.78	177.47	178.10	178.63	179.07	179.37	179.50	179.46
G 12.0	172.54	173.62	174.68	175.69	176.60	177.37	178.04	178.67	179.30	179.86	180.23	180.34	180.21
G 13.0	172.51	173.69	174.89	176.07	177.15	178.09	178.89	179.58	180.18	180.65	180.94	181.04	180.93
G 14.0	172.79	174.11	175.29	176.36	177.36	178.32	179.22	180.05	180.75	181.28	181.60	181.67	181.49
G 15.0	172.73	174.14	175.46	176.68	177.80	178.81	179.72	180.55	181.29	181.89	182.27	182.38	182.23
G 16.0	172.68	174.19	175.63	176.98	178.22	179.31	180.26	181.07	181.75	182.27	182.59	182.68	182.52
G 17.0	172.67	174.35	175.86	177.20	178.41	179.52	180.52	181.38	182.08	182.61	182.95	183.09	182.97
G 18.0	172.26	173.90	175.59	177.23	178.71	179.91	180.87	181.64	182.28	182.78	183.11	183.25	183.14
G 19.0	172.18	173.95	175.64	177.23	178.65	179.86	180.88	181.76	182.50	183.09	183.48	183.65	183.53
G 20.0	172.11	174.03	175.77	177.34	178.74	179.97	181.03	181.93	182.68	183.25	183.61	183.74	183.59
G 21.0	171.49	173.47	175.37	177.13	178.69	179.99	181.07	181.98	182.76	183.37	183.80	183.99	183.85
G 22.0	171.05	173.10	175.05	176.86	178.48	179.85	181.00	181.95	182.73	183.32	183.69	183.82	183.64
G 23.0	170.50	172.68	174.71	176.58	178.29	179.81	181.10	182.10	182.79	183.22	183.47	183.61	183.52
G 24.0	170.25	172.45	174.51	176.39	178.09	179.55	180.78	181.76	182.47	182.96	183.29	183.48	183.40
G 25.0	169.41	171.64	173.85	175.96	177.84	179.38	180.62	181.61	182.39	182.97	183.30	183.37	183.13
G 26.0	168.86	171.26	173.50	175.56	177.40	178.99	180.31	181.34	182.09	182.59	182.90	183.03	182.88
G 27.0	167.91	170.33	172.69	174.93	176.92	178.58	179.92	180.95	181.70	182.22	182.52	182.62	182.41
G 28.0	166.98	169.46	171.90	174.22	176.28	178.01	179.38	180.42	181.16	181.65	181.95	182.10	181.96
G 29.0	166.18	168.77	171.24	173.55	175.62	177.40	178.86	179.97	180.72	181.18	181.44	181.53	181.34
G 30.0	165.19	167.74	170.28	172.69	174.83	176.57	177.95	179.03	179.88	180.50	180.91	181.07	180.88
G 31.0	164.05	166.81	169.46	171.95	174.16	176.02	177.49	178.58	179.29	179.72	179.96	180.08	179.92
G 32.0	163.38	166.16	168.75	171.10	173.19	174.97	176.43	177.57	178.40	178.95	179.28	179.40	179.19
G 33.0	161.83	164.59	167.27	169.83	172.18	174.24	175.93	177.15	177.86	178.20	178.34	178.39	178.20
G 34.0	160.67	163.66	166.52	169.18	171.50	173.38	174.83	175.92	176.69	177.19	177.46	177.52	177.26
G 35.0	159.49	162.45	165.19	167.72	170.02	172.08	173.82	175.12	175.91	176.31	176.49	176.54	176.32
G 36.0	158.17	161.13	163.99	166.68	169.06	171.05	172.62	173.80	174.61	175.13	175.43	175.57	175.37
G 37.0	156.64	159.77	162.77	165.55	168.00	170.05	171.66	172.83	173.56	173.97	174.15	174.17	173.90
G 38.0	155.32	158.38	161.35	164.14	166.61	168.66	170.29	171.50	172.33	172.84	173.14	173.25	173.00
G 39.0	153.37	156.59	159.76	162.76	165.39	167.53	169.17	170.34	171.08	171.48	171.68	171.71	171.42
G 40.0	152.12	155.42	158.56	161.47	164.04	166.18	167.85	169.04	169.74	170.08	170.24	170.29	170.05
G 41.0	150.47	153.64	156.72	159.63	162.26	164.51	166.31	167.64	168.46	168.89	169.06	169.04	168.70
G 42.0	148.56	151.79	155.04	158.13	160.81	162.92	164.49	165.66	166.50	167.07	167.38	167.43	167.06
G 43.0	147.08	150.39	153.54	156.48	159.08	161.26	162.99	164.23	164.99	165.39	165.57	165.62	165.36
G 44.0	145.14	148.48	151.70	154.72	157.44	159.75	161.60	162.92	163.70	164.08	164.23	164.25	163.94
G 45.0	143.10	146.49	149.88	153.08	155.83	157.97	159.53	160.67	161.49	162.05	162.40	162.54	162.27
G 46.0	141.30	144.70	147.98	151.08	153.86	156.22	158.09	159.38	160.09	160.38	160.49	160.55	160.33
G 47.0	139.27	142.70	146.07	149.26	152.11	154.48	156.33	157.63	158.39	158.75	158.87	158.85	158.51
G 48.0	137.39	140.81	144.14	147.28	150.05	152.35	154.13	155.42	156.24	156.71	156.95	157.03	156.75
G 49.0	135.38	138.85	142.22	145.40	148.26	150.67	152.55	153.84	154.52	154.78	154.83	154.82	154.51
G 50.0	133.09	136.58	139.95	143.14	146.03	148.52	150.50	151.90	152.69	153.02	153.11	153.09	152.75
G 51.0	130.79	134.27	137.80	141.21	144.23	146.65	148.45	149.68	150.40	150.75	150.91	150.97	150.69
G 52.0	128.72	132.30	135.80	139.13	142.13	144.63	146.57	147.87	148.51	148.70	148.70	148.68	148.40
G 53.0	126.45	129.96	133.45	136.79	139.81	142.32	144.27	145.60	146.31	146.58	146.62	146.57	146.23
G 54.0	124.19	127.70	131.25	134.66	137.70	140.16	142.02	143.29	144.03	144.37	144.48	144.45	144.08
G 55.0	121.95	125.56	129.10	132.45	135.47	137.99	139.94	141.23	141.85	142.00	141.94	141.84	141.49
G 56.0	119.68	123.29	126.80	130.10	133.05	135.52	137.43	138.75	139.47	139.76	139.81	139.76	139.39
G 57.0	116.95	120.52	124.14	127.65	130.80	133.36	135.28	136.54	137.17	137.36	137.36	137.29	136.94
G 58.0	114.63	118.29	121.87	125.26	128.31	130.88	132.88	134.22	134.86	135.02	134.99	134.93	134.60
G 59.0	112.18	115.76	119.34	122.80	125.91	128.48	130.44	131.76	132.43	132.64	132.63	132.54	132.14
G 60.0	109.61	113.24	116.86	120.31	123.41	125.99	127.95	129.27	129.92	130.12	130.10	130.03	129.66
G 61.0	107.17	110.78	114.31	117.68	120.72	123.30	125.31	126.67	127.36	127.57	127.53	127.40	126.98
G 62.0	104.47	108.09	111.71	115.19	118.32	120.94	122.96	124.31	125.00	125.21	125.16	125.01	124.54
G 63.0	101.83	105.56	109.23	112.70	115.82	118.43	120.45	121.78	122.40	122.52	122.41	122.24	121.80
G 64.0	99.08	102.75	106.39	109.87	113.03	115.70	117.78	119.18	119.86	120.02	119.95	119.80	119.35
G 65.0	96.41	100.12	103.83	107.39	110.59	113.25	115.27	116.59	117.18	117.30	117.25	117.22	116.90
G 66.0	93.75	97.42	101.05	104.53	107.66	110.28	112.32	113.73	114.48	114.76	114.80	114.74	114.33
G 67.0	90.94	94.63	98.29	101.79	104.95	107.60	109.64	111.01	111.69	111.88	111.86	111.79	111.42
G 68.0	88.09	91.82	95.57	99.17	102.40	105.04	107.06	108.42	109.14	109.41	109.43	109.34	108.89
G 69.0	85.40	89.11	92.81	96.36	99.57	102.24	104.31	105.72	106.48	106.75	106.75	106.62	106.13
G 70.0	82.36	86.03	89.73	93.34	96.66	99.50	101.74	103.24	103.96	104.11	104.02	103.86	103.40
G 71.0	79.57	83.28	87.01	90.66	94.04	96.96	99.21	100.57	100.95	100.74	100.44	100.39	100.23
G 72.0	76.85	80.50	84.18	87.77	91.11	93.99	96.21	97.54	97.87	97.57	97.11	96.84	96.49

LEDS C4⁺

Luminaire

Code PX-0525-ANT
Name KAPA

Measurerm.

Code PX-0525-ANT
Name KAPA

Luminaire Flux	443.60 lm	Luminaire Power	10.30 W	Efficacy	43.07 lm/W	Efficiency	100.00%
Sources Flux	443.60 lm	Maximum value	183.99 cd/klm	Position	C=175.00 G=159.00	CG	Asymmetrical

Luminous Intensity Table cd/klm Table 4/18

	C 195.00	C 200.00	C 205.00	C 210.00	C 215.00	C 220.00	C 225.00	C 230.00	C 235.00	C 240.00	C 245.00	C 250.00	C 255.00
G 0.0	166.95	166.86	166.80	166.72	166.61	166.46	166.29	166.11	165.99	166.04	166.29	166.56	166.65
G 1.0	168.57	168.37	168.13	167.91	167.72	167.55	167.38	167.18	167.02	166.96	166.96	166.97	166.98
G 2.0	169.60	169.49	169.38	169.24	169.03	168.75	168.40	168.02	167.68	167.50	167.46	167.42	167.38
G 3.0	171.02	170.82	170.60	170.36	170.07	169.73	169.31	168.83	168.39	168.14	168.05	167.97	167.89
G 4.0	172.22	171.94	171.65	171.35	171.03	170.65	170.17	169.57	168.99	168.58	168.43	168.29	167.87
G 5.0	173.44	173.09	172.68	172.29	171.95	171.57	171.05	170.34	169.59	169.02	168.74	168.51	167.99
G 6.0	174.60	174.23	173.78	173.32	172.87	172.36	171.72	170.91	170.07	169.44	169.12	168.81	168.15
G 7.0	175.70	175.34	174.88	174.37	173.81	173.18	172.43	171.53	170.62	169.85	169.32	168.78	167.94
G 8.0	176.52	176.13	175.69	175.18	174.58	173.87	172.99	171.96	170.92	170.09	169.57	169.06	168.16
G 9.0	177.58	177.15	176.58	175.92	175.18	174.35	173.39	172.31	171.24	170.33	169.67	168.99	167.95
G 10.0	178.53	178.00	177.31	176.49	175.60	174.65	173.63	172.56	171.51	170.55	169.71	168.81	167.59
G 11.0	179.21	178.75	178.11	177.33	176.44	175.44	174.29	173.01	171.70	170.53	169.56	168.58	167.33
G 12.0	179.89	179.41	178.76	177.95	177.05	176.05	174.88	173.53	172.18	170.89	169.64	168.54	167.11
G 13.0	180.61	180.09	179.37	178.49	177.44	176.24	174.88	173.39	171.88	170.49	169.28	168.07	166.58
G 14.0	181.11	180.54	179.80	178.88	177.78	176.51	175.06	173.45	171.81	170.31	169.02	167.74	166.17
G 15.0	181.81	181.14	180.26	179.19	177.97	176.60	175.07	173.42	171.76	170.27	169.01	167.71	166.04
G 16.0	182.10	181.42	180.51	179.43	178.20	176.82	175.26	173.52	171.74	170.04	168.51	166.95	165.09
G 17.0	182.56	181.83	180.82	179.62	178.29	176.81	175.16	173.33	171.45	169.70	168.15	166.56	164.60
G 18.0	182.70	181.89	180.80	179.53	178.16	176.67	175.01	173.15	171.22	169.36	167.66	165.89	163.77
G 19.0	183.06	182.23	181.09	179.74	178.26	176.65	174.87	172.95	170.96	169.04	167.24	165.35	163.08
G 20.0	183.08	182.19	181.00	179.62	178.13	176.49	174.65	172.59	170.44	168.40	166.55	164.65	162.35
G 21.0	183.30	182.27	180.89	179.35	177.77	176.12	174.29	172.25	170.11	168.01	166.04	163.98	161.55
G 22.0	183.10	182.18	180.93	179.44	177.78	175.95	173.94	171.77	169.51	167.29	165.16	162.96	160.46
G 23.0	183.05	182.12	180.80	179.22	177.50	175.62	173.54	171.27	168.90	166.55	164.30	162.00	159.44
G 24.0	182.92	181.92	180.50	178.83	177.02	175.07	172.93	170.60	168.16	165.74	163.40	160.98	158.29
G 25.0	182.52	181.52	180.17	178.57	176.78	174.78	172.55	170.10	167.53	164.98	162.53	160.02	157.21
G 26.0	182.32	181.25	179.77	178.00	176.07	173.95	171.64	169.14	166.54	163.96	161.48	158.89	155.96
G 27.0	181.77	180.60	179.05	177.27	175.40	173.38	171.10	168.52	165.76	163.04	160.46	157.82	154.84
G 28.0	181.40	180.30	178.76	176.93	174.90	172.68	170.23	167.54	164.74	161.97	159.31	156.57	153.49
G 29.0	180.72	179.54	177.93	176.04	174.00	171.77	169.30	166.56	163.67	160.82	158.09	155.32	152.23
G 30.0	180.18	178.88	177.14	175.18	173.14	170.96	168.50	165.67	162.65	159.66	156.83	153.97	150.81
G 31.0	179.30	178.09	176.41	174.44	172.30	169.98	167.40	164.51	161.47	158.46	155.60	152.68	149.43
G 32.0	178.51	177.26	175.55	173.54	171.35	168.96	166.29	163.33	160.23	157.16	154.25	151.29	147.98
G 33.0	177.54	176.23	174.43	172.36	170.19	167.84	165.20	162.21	159.03	155.91	152.96	149.94	146.51
G 34.0	176.54	175.26	173.52	171.46	169.19	166.69	163.91	160.82	157.59	154.40	151.38	148.29	144.81
G 35.0	175.63	174.31	172.48	170.32	167.97	165.40	162.55	159.41	156.12	152.85	149.72	146.53	143.01
G 36.0	174.61	173.14	171.15	168.88	166.52	164.02	161.23	158.10	154.76	151.42	148.21	144.93	141.33
G 37.0	173.15	171.79	169.95	167.79	165.45	162.87	159.97	156.69	153.22	149.76	146.46	143.13	139.50
G 38.0	172.16	170.59	168.49	166.17	163.84	161.38	158.56	155.26	151.68	148.12	144.78	141.45	137.83
G 39.0	170.58	169.05	167.00	164.71	162.37	159.85	156.99	153.67	150.07	146.49	143.08	139.64	135.90
G 40.0	169.24	167.71	165.64	163.31	160.93	158.38	155.46	152.06	148.39	144.75	141.31	137.85	134.03
G 41.0	167.81	166.27	164.20	161.86	159.39	156.72	153.69	150.23	146.53	142.86	139.39	135.88	132.03
G 42.0	166.12	164.49	162.36	160.02	157.63	155.07	152.12	148.65	144.86	141.08	137.50	133.91	130.02
G 43.0	164.54	163.02	160.94	158.56	156.06	153.34	150.27	146.77	143.02	139.25	135.64	131.98	128.00
G 44.0	163.05	161.40	159.19	156.73	154.22	151.53	148.45	144.85	140.97	137.11	133.48	129.88	125.96
G 45.0	161.36	159.65	157.39	154.88	152.37	149.70	146.64	143.02	139.10	135.19	131.51	127.84	123.84
G 46.0	159.50	157.84	155.58	153.06	150.52	147.81	144.69	141.03	137.05	133.10	129.40	125.71	121.68
G 47.0	157.59	155.93	153.71	151.21	148.61	145.80	142.61	138.93	134.96	130.99	127.22	123.44	119.35
G 48.0	155.82	154.08	151.75	149.17	146.55	143.77	140.61	136.92	132.92	128.89	125.04	121.18	117.04
G 49.0	153.62	151.92	149.65	147.11	144.54	141.79	138.62	134.89	130.83	126.77	122.93	119.10	114.94
G 50.0	151.80	150.06	147.73	145.12	142.45	139.60	136.35	132.56	128.46	124.39	120.55	116.71	112.53
G 51.0	149.73	147.91	145.49	142.85	140.29	137.58	134.41	130.58	126.36	122.14	118.19	114.29	110.07
G 52.0	147.51	145.80	143.48	140.85	138.16	135.28	131.97	128.13	123.97	119.85	115.97	112.09	107.85
G 53.0	145.27	143.52	141.19	138.58	135.92	133.06	129.77	125.90	121.70	117.50	113.53	109.57	105.31
G 54.0	143.10	141.33	138.98	136.35	133.66	130.77	127.45	123.56	119.33	115.10	111.08	107.07	102.75
G 55.0	140.59	138.91	136.65	134.08	131.40	128.48	125.11	121.17	116.91	112.69	108.73	104.77	100.42
G 56.0	138.42	136.66	134.31	131.65	128.91	125.95	122.56	118.64	114.39	110.15	106.13	102.10	97.72
G 57.0	135.98	134.20	131.82	129.16	126.46	123.54	120.16	116.17	111.84	107.54	103.52	99.53	95.20
G 58.0	133.66	131.86	129.45	126.75	124.01	121.07	117.68	113.67	109.33	105.01	100.97	96.96	92.62
G 59.0	131.13	129.31	126.89	124.20	121.47	118.54	115.15	111.14	106.78	102.43	98.34	94.27	89.88
G 60.0	128.66	126.82	124.36	121.66	118.95	116.06	112.69	108.67	104.26	99.85	95.69	91.57	87.14
G 61.0	125.96	124.16	121.78	119.11	116.37	113.41	109.99	105.96	101.59	97.22	93.09	88.99	84.57
G 62.0	123.47	121.60	119.16	116.47	113.75	110.83	107.42	103.36	98.93	94.50	90.35	86.25	81.84
G 63.0	120.78	118.95	116.53	113.82	111.03	108.02	104.58	100.57	96.21	91.83	87.64	83.46	78.99
G 64.0	118.27	116.35	113.84	111.10	108.37	105.46	102.07	98.00	93.55	89.09	84.89	80.74	76.27
G 65.0	115.90	113.95	111.32	108.43	105.59	102.61	99.19	95.15	90.73	86.32	82.16	78.02	73.56
G 66.0	113.24	111.27	108.67	105.80	102.93	99.90	96.43	92.37	87.93	83.48	79.23	75.02	70.54
G 67.0	110.38	108.43	105.83	102.98	100.13	97.11	93.66	89.60	85.17	80.71	76.48	72.28	67.80
G 68.0	107.78	105.80	103.18	100.29	97.36	94.26	90.74	86.63	82.20	77.77	73.60	69.45	64.99
G 69.0	104.99	103.00	100.40	97.51	94.58	91.45	87.91	83.80	79.36	74.92	70.70	66.51	62.05
G 70.0	102.28	100.26	97.60	94.66	91.73	88.63	85.10	80.98	76.50	72.02	67.78	63.58	59.14
G 71.0	99.41	97.54	94.90	91.90	88.86	85.67	82.10	78.01	73.62	69.20	64.96	60.73	56.24
G 72.0	95.64	94.01	91.72	89.02	86.09	82.86	79.20	75.04	70.60	66.16	61.92	57.69	53.23

LEDS C4⁺

Luminaire

Code PX-0525-ANT
Name KAPA

Measurerm.

Code PX-0525-ANT
Name KAPA

Luminaire Flux	443.60 lm	Luminaire Power	10.30 W	Efficacy	43.07 lm/W	Efficiency	100.00%
Sources Flux	443.60 lm	Maximum value	183.99 cd/klm	Position	C=175.00 G=159.00	CG	Asymmetrical

Luminous Intensity Table cd/klm Table 5/18

	C 260.00	C 265.00	C 270.00	C 275.00	C 280.00	C 285.00	C 290.00	C 295.00	C 300.00	C 305.00	C 310.00	C 315.00	C 320.00
G 0.0	166.38	165.91	165.44	165.14	165.02	165.04	165.14	165.28	165.38	165.37	165.37	165.36	165.34
G 1.0	166.60	166.05	165.54	165.19	164.98	164.86	164.77	164.70	164.66	164.64	164.59	164.43	164.14
G 2.0	166.83	166.05	165.29	164.71	164.33	164.09	163.93	163.83	163.72	163.58	163.40	163.20	163.00
G 3.0	167.10	166.03	165.03	164.37	163.96	163.66	163.34	163.00	162.67	162.37	162.08	161.82	161.56
G 4.0	166.95	165.77	164.67	163.90	163.40	163.01	162.61	162.19	161.80	161.44	161.08	160.68	160.20
G 5.0	166.95	165.62	164.38	163.48	162.87	162.39	161.92	161.42	160.89	160.32	159.77	159.27	158.87
G 6.0	166.88	165.29	163.85	162.87	162.24	161.73	161.15	160.52	159.88	159.25	158.64	158.03	157.40
G 7.0	166.59	165.00	163.54	162.49	161.73	161.04	160.26	159.41	158.59	157.86	157.19	156.53	155.87
G 8.0	166.63	164.77	163.03	161.74	160.82	160.06	159.28	158.46	157.59	156.70	155.84	155.04	154.37
G 9.0	166.34	164.42	162.61	161.23	160.18	159.27	158.37	157.44	156.49	155.53	154.57	153.64	152.76
G 10.0	165.91	164.01	162.21	160.75	159.56	158.45	157.30	156.13	155.01	154.00	153.06	152.14	151.21
G 11.0	165.63	163.66	161.72	160.04	158.58	157.28	156.04	154.86	153.70	152.56	151.45	150.40	149.42
G 12.0	165.19	163.02	160.92	159.15	157.66	156.28	154.92	153.59	152.35	151.22	150.14	149.05	147.90
G 13.0	164.66	162.48	160.35	158.48	156.83	155.27	153.73	152.22	150.81	149.54	148.36	147.19	145.98
G 14.0	164.13	161.82	159.54	157.52	155.74	154.08	152.46	150.90	149.43	148.06	146.76	145.50	144.24
G 15.0	163.77	161.18	158.67	156.54	154.70	152.96	151.17	149.40	147.75	146.30	144.98	143.68	142.34
G 16.0	162.76	160.17	157.63	155.37	153.34	151.42	149.53	147.71	146.06	144.63	143.32	141.99	140.55
G 17.0	162.05	159.19	156.44	154.10	152.09	150.19	148.29	146.41	144.63	143.02	141.54	140.12	138.71
G 18.0	161.12	158.22	155.44	153.08	151.01	149.08	147.15	145.22	143.30	141.47	139.74	138.11	136.56
G 19.0	160.25	157.17	154.25	151.77	149.61	147.53	145.36	143.19	141.15	139.35	137.73	136.18	134.63
G 20.0	159.45	156.25	153.19	150.59	148.32	146.16	143.93	141.69	139.56	137.64	135.88	134.21	132.57
G 21.0	158.57	155.33	152.21	149.50	147.08	144.72	142.24	139.78	137.53	135.61	133.91	132.27	130.56
G 22.0	157.52	154.35	151.20	148.30	145.61	143.03	140.49	138.07	135.85	133.89	132.10	130.35	128.56
G 23.0	156.47	153.27	150.09	147.11	144.31	141.62	138.97	136.43	134.05	131.89	129.90	128.02	126.21
G 24.0	155.19	151.85	148.55	145.46	142.56	139.78	137.05	134.44	132.06	129.97	128.05	126.17	124.23
G 25.0	153.96	150.49	147.07	143.94	141.02	138.17	135.29	132.52	130.01	127.88	125.97	124.08	122.08
G 26.0	152.54	148.89	145.37	142.25	139.41	136.64	133.79	130.94	128.26	125.85	123.68	121.65	119.70
G 27.0	151.36	147.61	143.94	140.61	137.55	134.61	131.66	128.79	126.15	123.80	121.66	119.57	117.45
G 28.0	149.89	146.04	142.31	138.95	135.88	132.88	129.84	126.86	124.12	121.72	119.57	117.51	115.43
G 29.0	148.67	144.86	141.10	137.63	134.37	131.18	127.99	124.87	121.99	119.43	117.13	114.98	112.90
G 30.0	147.16	143.24	139.36	135.77	132.42	129.18	125.99	122.91	120.06	117.50	115.15	112.88	110.61
G 31.0	145.66	141.62	137.65	134.01	130.62	127.32	124.01	120.78	117.78	115.13	112.73	110.46	108.23
G 32.0	144.16	140.05	136.00	132.27	128.79	125.41	122.05	118.78	115.74	113.01	110.53	108.19	105.90
G 33.0	142.45	138.09	133.89	130.19	126.82	123.50	120.05	116.60	113.42	110.67	108.22	105.89	103.54
G 34.0	140.75	136.40	132.16	128.35	124.85	121.42	117.92	114.47	111.26	108.44	105.91	103.53	101.21
G 35.0	139.00	134.72	130.49	126.56	122.86	119.27	115.68	112.21	108.99	106.13	103.52	101.05	98.61
G 36.0	137.23	132.87	128.59	124.62	120.90	117.25	113.57	109.99	106.72	103.87	101.31	98.83	96.31
G 37.0	135.39	131.03	126.72	122.69	118.88	115.13	111.33	107.64	104.26	101.34	98.75	96.28	93.80
G 38.0	133.70	129.28	124.87	120.73	116.79	112.94	109.11	105.41	102.02	99.05	96.37	93.80	91.24
G 39.0	131.64	127.12	122.66	118.53	114.64	110.80	106.92	103.12	99.63	96.57	93.83	91.25	88.69
G 40.0	129.64	124.94	120.34	116.12	112.20	108.39	104.54	100.79	97.31	94.24	91.48	88.86	86.29
G 41.0	127.62	122.92	118.31	114.09	110.15	106.27	102.33	98.46	94.86	91.68	88.82	86.14	83.54
G 42.0	125.62	120.94	116.31	111.98	107.88	103.88	99.88	96.01	92.44	89.30	86.47	83.76	81.07
G 43.0	123.51	118.76	114.06	109.68	105.55	101.53	97.52	93.64	90.05	86.86	83.96	81.20	78.48
G 44.0	121.51	116.76	112.05	107.63	103.44	99.32	95.20	91.21	87.52	84.27	81.35	78.56	75.80
G 45.0	119.28	114.42	109.64	105.20	101.02	96.92	92.77	88.72	84.98	81.68	78.72	75.92	73.17
G 46.0	117.06	112.13	107.25	102.73	98.48	94.34	90.19	86.16	82.43	79.11	76.12	73.30	70.55
G 47.0	114.75	109.87	105.04	100.52	96.24	92.04	87.83	83.73	79.93	76.55	73.50	70.63	67.85
G 48.0	112.43	107.55	102.70	98.11	93.74	89.48	85.26	81.19	77.40	73.99	70.88	67.96	65.13
G 49.0	110.24	105.24	100.31	95.71	91.36	87.09	82.80	78.63	74.77	71.35	68.28	65.38	62.55
G 50.0	107.79	102.74	97.76	93.12	88.75	84.47	80.18	75.99	72.12	68.69	65.59	62.67	59.82
G 51.0	105.30	100.23	95.24	90.60	86.23	81.94	77.60	73.37	69.46	66.02	62.92	59.99	57.12
G 52.0	103.00	97.82	92.72	88.00	83.58	79.28	74.98	70.78	66.87	63.35	60.17	57.19	54.35
G 53.0	100.53	95.45	90.41	85.66	81.14	76.73	72.35	68.11	64.20	60.72	57.57	54.60	51.71
G 54.0	97.92	92.82	87.78	83.05	78.56	74.15	69.72	65.40	61.42	57.91	54.76	51.80	48.90
G 55.0	95.44	90.12	84.93	80.21	75.82	71.53	67.18	62.89	58.89	55.31	52.08	49.06	46.17
G 56.0	92.79	87.56	82.41	77.64	73.15	68.76	64.37	60.10	56.14	52.64	49.47	46.48	43.56
G 57.0	90.28	85.04	79.90	75.16	70.69	66.28	61.79	57.38	53.30	49.74	46.57	43.62	40.76
G 58.0	87.71	82.49	77.32	72.51	67.97	63.52	59.06	54.71	50.68	47.11	43.91	40.91	38.03
G 59.0	84.96	79.74	74.59	69.80	65.27	60.82	56.35	52.00	47.97	44.42	41.24	38.28	35.43
G 60.0	82.18	76.95	71.81	67.04	62.55	58.12	53.63	49.24	45.19	41.64	38.49	35.56	32.74
G 61.0	79.61	74.36	69.19	64.37	59.82	55.38	50.92	46.59	42.58	39.02	35.83	32.88	30.06
G 62.0	76.91	71.68	66.49	61.63	57.03	52.54	48.08	43.78	39.82	36.34	33.23	30.33	27.56
G 63.0	74.05	68.86	63.75	58.97	54.42	49.93	45.42	41.03	37.01	33.52	30.45	27.61	24.89
G 64.0	71.26	65.98	60.80	56.00	51.51	47.11	42.69	38.39	34.44	30.99	27.94	25.11	22.41
G 65.0	68.56	63.26	58.07	53.27	48.77	44.38	39.98	35.71	31.79	28.38	25.38	22.62	19.98
G 66.0	65.62	60.47	55.38	50.60	46.06	41.64	37.24	33.01	29.14	25.76	22.78	20.06	17.50
G 67.0	62.85	57.66	52.56	47.80	43.32	38.97	34.64	30.47	26.64	23.28	20.32	17.63	15.14
G 68.0	60.00	54.75	49.60	44.86	40.43	36.14	31.88	27.78	24.03	20.76	17.91	15.33	12.94
G 69.0	57.12	51.96	46.91	42.21	37.80	33.52	29.27	25.19	21.48	18.29	15.53	13.06	10.78
G 70.0	54.28	49.20	44.21	39.54	35.14	30.88	26.67	22.65	19.02	15.89	13.20	10.81	8.64
G 71.0	51.34	46.25	41.28	36.67	32.36	28.20	24.10	20.19	16.66	13.63	11.05	8.79	6.76
G 72.0	48.37	43.34	38.45	33.96	29.76	25.69	21.64	17.76	14.29	11.38	8.95	6.82	4.90

LEDS C4⁺

Luminaire

Code PX-0525-ANT
Name KAPA

Measurment

Code PX-0525-ANT
Name KAPA

Luminaire Flux	443.60 lm	Luminaire Power	10.30 W	Efficacy	43.07 lm/W	Efficiency	100.00%
Sources Flux	443.60 lm	Maximum value	183.99 cd/klm	Position	C=175.00 G=159.00	CG	Asymmetrical

Luminous Intensity Table cd/klm Table 6/18

	C 325.00	C 330.00	C 335.00	C 340.00	C 345.00	C 350.00	C 355.00
G 0.0	165.33	165.33	165.35	165.43	165.62	165.97	166.43
G 1.0	163.83	163.66	163.73	164.00	164.35	164.70	165.04
G 2.0	162.80	162.63	162.52	162.51	162.65	162.99	163.47
G 3.0	161.34	161.15	161.02	160.99	161.11	161.41	161.85
G 4.0	159.73	159.37	159.22	159.25	159.44	159.75	160.14
G 5.0	158.54	158.23	157.93	157.71	157.69	157.95	158.41
G 6.0	156.81	156.34	156.04	155.93	156.01	156.26	156.65
G 7.0	155.25	154.74	154.40	154.25	154.29	154.51	154.86
G 8.0	153.79	153.30	152.88	152.58	152.50	152.67	153.03
G 9.0	151.98	151.36	150.96	150.77	150.77	150.92	151.19
G 10.0	150.32	149.57	149.00	148.67	148.59	148.76	149.11
G 11.0	148.54	147.79	147.22	146.86	146.73	146.85	147.15
G 12.0	146.77	145.80	145.10	144.69	144.57	144.75	145.14
G 13.0	144.84	143.91	143.29	142.96	142.85	142.92	143.10
G 14.0	143.06	142.01	141.17	140.61	140.36	140.46	140.81
G 15.0	141.04	139.94	139.14	138.65	138.46	138.55	138.84
G 16.0	139.13	137.92	137.06	136.55	136.34	136.39	136.62
G 17.0	137.37	136.15	135.14	134.40	134.02	134.05	134.38
G 18.0	135.05	133.75	132.81	132.22	131.98	132.03	132.29
G 19.0	133.16	131.88	130.87	130.19	129.84	129.82	130.03
G 20.0	131.03	129.68	128.58	127.82	127.43	127.43	127.72
G 21.0	128.90	127.48	126.44	125.78	125.46	125.42	125.57
G 22.0	126.83	125.33	124.18	123.41	123.01	122.95	123.15
G 23.0	124.54	123.08	121.92	121.10	120.67	120.62	120.85
G 24.0	122.36	120.74	119.54	118.74	118.34	118.30	118.49
G 25.0	120.12	118.41	117.14	116.31	115.90	115.87	116.09
G 26.0	117.88	116.26	114.92	113.93	113.39	113.35	113.66
G 27.0	115.42	113.70	112.43	111.62	111.22	111.18	111.39
G 28.0	113.43	111.65	110.21	109.18	108.61	108.51	108.74
G 29.0	110.95	109.23	107.82	106.80	106.23	106.13	106.37
G 30.0	108.47	106.61	105.18	104.21	103.71	103.66	103.94
G 31.0	106.15	104.35	102.94	101.97	101.43	101.30	101.47
G 32.0	103.76	101.88	100.38	99.31	98.71	98.59	98.83
G 33.0	101.31	99.38	97.92	96.92	96.39	96.26	96.43
G 34.0	99.02	97.10	95.57	94.47	93.83	93.65	93.80
G 35.0	96.33	94.35	92.81	91.74	91.15	91.03	91.23
G 36.0	93.89	91.80	90.21	89.15	88.59	88.48	88.70
G 37.0	91.43	89.38	87.80	86.71	86.09	85.93	86.07
G 38.0	88.80	86.69	85.06	83.94	83.33	83.18	83.37
G 39.0	86.27	84.17	82.53	81.40	80.78	80.67	80.92
G 40.0	83.85	81.72	80.03	78.82	78.15	78.00	78.23
G 41.0	81.11	78.99	77.32	76.14	75.47	75.31	75.52
G 42.0	78.52	76.32	74.62	73.46	72.82	72.67	72.87
G 43.0	75.91	73.68	71.94	70.74	70.07	69.92	70.14
G 44.0	73.20	70.96	69.22	68.03	67.37	67.21	67.41
G 45.0	70.58	68.35	66.60	65.39	64.71	64.56	64.76
G 46.0	67.98	65.74	63.97	62.71	61.99	61.79	61.97
G 47.0	65.27	63.03	61.27	60.03	59.32	59.11	59.27
G 48.0	62.50	60.23	58.44	57.17	56.46	56.29	56.51
G 49.0	59.89	57.57	55.75	54.47	53.75	53.57	53.78
G 50.0	57.16	54.85	53.03	51.76	51.04	50.84	51.03
G 51.0	54.42	52.06	50.22	48.92	48.20	48.03	48.26
G 52.0	51.73	49.44	47.61	46.29	45.52	45.32	45.52
G 53.0	49.01	46.68	44.86	43.58	42.84	42.64	42.80
G 54.0	46.20	43.86	42.03	40.76	40.04	39.87	40.08
G 55.0	43.50	41.19	39.38	38.09	37.37	37.19	37.40
G 56.0	40.82	38.48	36.67	35.42	34.72	34.53	34.70
G 57.0	38.10	35.79	33.98	32.71	32.00	31.81	32.00
G 58.0	35.36	33.08	31.31	30.08	29.39	29.22	29.42
G 59.0	32.79	30.52	28.75	27.51	26.80	26.61	26.77
G 60.0	30.11	27.86	26.12	24.90	24.23	24.06	24.25
G 61.0	27.47	25.26	23.55	22.36	21.70	21.55	21.75
G 62.0	25.00	22.81	21.12	19.96	19.31	19.13	19.30
G 63.0	22.38	20.24	18.61	17.48	16.86	16.71	16.88
G 64.0	19.92	17.81	16.21	15.13	14.55	14.42	14.61
G 65.0	17.58	15.54	13.99	12.94	12.37	12.23	12.39
G 66.0	15.19	13.24	11.77	10.77	10.23	10.10	10.26
G 67.0	12.90	11.03	9.63	8.69	8.19	8.10	8.29
G 68.0	10.81	9.03	7.70	6.82	6.35	6.25	6.41
G 69.0	8.75	7.07	5.83	5.01	4.58	4.50	4.65
G 70.0	6.73	5.18	4.04	3.32	2.95	2.90	3.07
G 71.0	5.02	3.62	2.62	2.01	1.74	1.77	2.01
G 72.0	3.26	2.06	1.39	1.12	1.09	1.15	1.25

LEDS C4⁺

Luminaire

Code PX-0525-ANT
Name KAPA

Measurement

Code PX-0525-ANT
Name KAPA

Luminaire Flux	443.60 lm	Luminaire Power	10.30 W	Efficacy	43.07 lm/W	Efficiency	100.00%
Sources Flux	443.60 lm	Maximum value	183.99 cd/klm	Position	C=175.00 G=159.00	CG	Asymmetrical

Luminous Intensity Table cd/klm Table 7/18

	C 0.00	C 5.00	C 10.00	C 15.00	C 20.00	C 25.00	C 30.00	C 35.00	C 40.00	C 45.00	C 50.00	C 55.00	C 60.00
G 73.0	1.25	1.34	1.43	1.52	1.60	1.68	1.75	2.62	4.05	6.01	8.47	11.32	14.42
G 74.0	1.22	1.46	1.57	1.45	1.17	0.90	0.62	1.23	2.47	4.28	6.56	9.23	12.18
G 75.0	1.25	1.48	1.59	1.48	1.09	0.63	0.35	0.50	1.20	2.54	4.58	7.15	10.07
G 76.0	1.28	1.52	1.64	1.51	1.07	0.52	0.09	0.01	0.43	1.44	3.11	5.34	7.97
G 77.0	1.30	1.52	1.64	1.54	1.16	0.63	0.10	0.00	0.00	0.34	1.64	3.57	5.97
G 78.0	1.24	1.45	1.56	1.47	1.10	0.59	0.11	0.00	0.00	0.17	0.98	2.30	4.18
G 79.0	1.10	1.29	1.39	1.30	0.97	0.53	0.14	0.00	0.00	0.15	0.53	1.28	2.63
G 80.0	0.94	1.11	1.20	1.12	0.82	0.45	0.16	0.10	0.15	0.17	0.47	0.78	1.08
G 81.0	0.82	0.96	1.03	0.95	0.70	0.38	0.17	0.16	0.23	0.18	0.22	0.26	0.30
G 82.0	0.84	0.96	1.01	0.93	0.69	0.40	0.19	0.19	0.19	0.19	0.01	0.00	0.16
G 83.0	0.93	1.02	1.06	0.97	0.73	0.43	0.21	0.20	0.20	0.20	0.15	0.10	0.16
G 84.0	1.02	1.12	1.16	1.06	0.80	0.48	0.23	0.22	0.22	0.22	0.21	0.18	0.17
G 85.0	1.07	1.20	1.24	1.15	0.87	0.53	0.25	0.24	0.24	0.23	0.27	0.26	0.18
G 86.0	1.14	1.31	1.40	1.31	0.99	0.59	0.28	0.31	0.35	0.38	0.33	0.28	0.22
G 87.0	1.31	1.51	1.60	1.51	1.17	0.73	0.41	0.45	0.49	0.53	0.45	0.37	0.29
G 88.0	1.53	1.70	1.79	1.68	1.35	0.94	0.66	0.66	0.81	0.91	0.83	0.61	0.36
G 89.0	1.74	1.88	1.94	1.84	1.53	1.16	0.92	0.93	1.07	1.11	0.94	0.64	0.37
G 90.0	3.75	3.81	3.79	3.62	3.27	2.85	2.52	2.38	2.30	2.07	1.59	1.02	0.63
G 91.0	1.74	1.69	1.64	1.57	1.48	1.36	1.23	1.08	0.91	0.70	0.47	0.27	0.16
G 92.0	1.53	1.49	1.44	1.38	1.29	1.19	1.07	0.93	0.78	0.61	0.41	0.24	0.14
G 93.0	1.31	1.28	1.24	1.19	1.11	1.01	0.91	0.79	0.66	0.51	0.36	0.22	0.12
G 94.0	1.14	1.10	1.06	1.02	0.95	0.87	0.78	0.66	0.53	0.42	0.33	0.24	0.11
G 95.0	1.07	1.02	0.96	0.90	0.82	0.74	0.64	0.54	0.44	0.37	0.33	0.27	0.10
G 96.0	1.02	0.95	0.88	0.80	0.72	0.63	0.55	0.47	0.41	0.39	0.39	0.34	0.12
G 97.0	0.93	0.87	0.80	0.73	0.65	0.57	0.50	0.46	0.44	0.41	0.36	0.27	0.15
G 98.0	0.84	0.79	0.74	0.67	0.60	0.53	0.51	0.50	0.49	0.48	0.39	0.31	0.22
G 99.0	0.82	0.77	0.72	0.67	0.66	0.64	0.63	0.59	0.56	0.52	0.43	0.34	0.25
G100.0	0.94	0.88	0.82	0.77	0.76	0.74	0.73	0.65	0.58	0.51	0.44	0.38	0.31
G101.0	1.10	1.02	0.95	0.89	0.85	0.82	0.79	0.74	0.66	0.49	0.76	1.03	1.29
G102.0	1.24	1.15	1.07	1.00	0.94	0.88	0.80	0.68	0.56	0.47	0.51	0.98	2.27
G103.0	1.30	1.20	1.11	1.04	0.99	0.91	0.77	0.55	0.39	0.50	1.05	2.18	4.03
G104.0	1.28	1.17	1.08	1.01	0.96	0.90	0.74	0.74	0.74	0.74	1.74	3.43	5.79
G105.0	1.25	1.17	1.09	0.99	0.88	0.78	0.71	0.73	1.00	1.75	3.12	5.13	7.74
G106.0	1.22	1.17	1.09	0.96	0.78	0.67	0.77	1.19	2.00	3.24	4.94	7.14	9.87
G107.0	1.25	1.19	1.11	0.96	0.99	1.02	1.05	1.90	3.23	4.92	6.90	9.23	12.05
G108.0	1.37	1.25	1.15	1.09	1.12	1.39	2.06	3.26	4.90	6.82	8.95	11.38	14.29
G109.0	2.36	2.01	1.77	1.74	2.01	2.62	3.62	5.02	6.76	8.79	11.05	13.63	16.66
G110.0	3.34	3.07	2.90	2.95	3.32	4.04	5.18	6.73	8.64	10.81	13.20	15.89	19.02
G111.0	4.92	4.65	4.50	4.58	5.01	5.83	7.07	8.75	10.78	13.06	15.53	18.29	21.48
G112.0	6.71	6.41	6.25	6.35	6.82	7.70	9.03	10.81	12.94	15.33	17.91	20.76	24.03
G113.0	8.62	8.29	8.10	8.19	8.69	9.63	11.03	12.90	15.14	17.63	20.32	23.28	26.64
G114.0	10.57	10.26	10.10	10.23	10.77	11.77	13.24	15.19	17.50	20.06	22.78	25.76	29.14
G115.0	12.71	12.39	12.23	12.37	12.94	13.99	15.54	17.58	19.98	22.62	25.38	28.38	31.79
G116.0	14.96	14.61	14.42	14.55	15.13	16.21	17.81	19.92	22.41	25.11	27.94	30.99	34.44
G117.0	17.22	16.88	16.71	16.86	17.48	18.61	20.24	22.38	24.89	27.61	30.45	33.52	37.01
G118.0	19.63	19.30	19.13	19.31	19.96	21.12	22.81	25.00	27.56	30.33	33.23	36.34	39.82
G119.0	22.14	21.75	21.55	21.70	22.36	23.55	25.26	27.47	30.06	32.88	35.83	39.02	42.58
G120.0	24.63	24.25	24.06	24.23	24.90	26.12	27.86	30.11	32.74	35.56	38.49	41.64	45.19
G121.0	27.12	26.77	26.61	26.80	27.51	28.75	30.52	32.79	35.43	38.28	41.24	44.42	47.97
G122.0	29.80	29.42	29.22	29.39	30.08	31.31	33.08	35.36	38.03	40.91	43.91	47.11	50.68
G123.0	32.37	32.00	31.81	32.00	32.71	33.98	35.79	38.10	40.76	43.62	46.57	49.74	53.30
G124.0	35.05	34.70	34.53	34.72	35.42	36.67	38.48	40.82	43.56	46.48	49.47	52.64	56.14
G125.0	37.80	37.40	37.19	37.37	38.09	39.38	41.19	43.50	46.17	49.06	52.08	55.31	58.89
G126.0	40.48	40.08	39.87	40.04	40.76	42.03	43.86	46.20	48.90	51.80	54.76	57.91	61.42
G127.0	43.15	42.80	42.64	42.84	43.58	44.86	46.68	49.01	51.71	54.60	57.57	60.72	64.20
G128.0	45.92	45.52	45.32	45.52	46.29	47.61	49.44	51.73	54.35	57.19	60.17	63.35	66.87
G129.0	48.69	48.26	48.03	48.20	48.92	50.22	52.06	54.42	57.12	59.99	62.92	66.02	69.46
G130.0	51.40	51.03	50.84	51.04	51.76	53.03	54.85	57.16	59.82	62.67	65.59	68.69	72.12
G131.0	54.18	53.78	53.57	53.75	54.47	55.75	57.57	59.89	62.55	65.38	68.28	71.35	74.77
G132.0	56.93	56.51	56.29	56.46	57.17	58.44	60.23	62.50	65.13	67.96	70.88	73.99	77.40
G133.0	59.60	59.27	59.11	59.32	60.03	61.27	63.03	65.27	67.85	70.63	73.50	76.55	79.93
G134.0	62.34	61.97	61.79	61.99	62.71	63.97	65.74	67.98	70.55	73.30	76.12	79.11	82.43
G135.0	65.15	64.76	64.56	64.71	65.39	66.60	68.35	70.58	73.17	75.92	78.72	81.68	84.98
G136.0	67.78	67.41	67.21	67.37	68.03	69.22	70.96	73.20	75.80	78.56	81.35	84.27	87.52
G137.0	70.54	70.14	69.92	70.07	70.74	71.94	73.68	75.91	78.48	81.20	83.96	86.86	90.05
G138.0	73.25	72.87	72.67	72.82	73.46	74.62	76.32	78.52	81.07	83.76	86.47	89.30	92.44
G139.0	75.90	75.52	75.31	75.47	76.14	77.32	78.99	81.11	83.54	86.14	88.82	91.68	94.86
G140.0	78.65	78.23	78.00	78.15	78.82	80.03	81.72	83.85	86.29	88.86	91.48	94.24	97.31
G141.0	81.35	80.92	80.67	80.78	81.40	82.53	84.17	86.27	88.69	91.25	93.83	96.57	99.63
G142.0	83.72	83.37	83.18	83.33	83.94	85.06	86.69	88.80	91.24	93.80	96.37	99.05	102.02
G143.0	86.38	86.07	85.93	86.09	86.71	87.80	89.38	91.43	93.80	96.28	98.75	101.34	104.26
G144.0	89.07	88.70	88.48	88.59	89.15	90.21	91.80	93.89	96.31	98.83	101.31	103.87	106.72
G145.0	91.59	91.23	91.03	91.15	91.74	92.81	94.35	96.33	98.61	101.05	103.52	106.13	108.99

LEDS C4⁺

Luminaire

Code PX-0525-ANT
Name KAPA

Measurement

Code PX-0525-ANT
Name KAPA

Luminaire Flux	443.60 lm	Luminaire Power	10.30 W	Efficacy	43.07 lm/W	Efficiency	100.00%
Sources Flux	443.60 lm	Maximum value	183.99 cd/klm	Position	C=175.00 G=159.00	CG Asymmetrical	

Luminous Intensity Table cd/klm Table 8/18

	C 65.00	C 70.00	C 75.00	C 80.00	C 85.00	C 90.00	C 95.00	C 100.00	C 105.00	C 110.00	C 115.00	C 120.00	C 125.00
G 73.0	17.70	21.23	25.13	29.44	34.00	38.57	42.98	47.35	51.86	56.61	61.40	65.93	70.00
G 74.0	15.36	18.81	22.63	26.85	31.32	35.81	40.18	44.53	49.01	53.73	58.49	63.01	67.11
G 75.0	13.17	16.52	20.21	24.31	28.66	33.06	37.38	41.69	46.17	50.89	55.66	60.21	64.34
G 76.0	10.88	14.11	17.75	21.81	26.13	30.51	34.79	39.06	43.46	48.07	52.72	57.19	61.30
G 77.0	8.71	11.83	15.36	19.33	23.57	27.85	32.03	36.21	40.55	45.16	49.83	54.28	58.32
G 78.0	6.65	9.66	13.15	17.04	21.15	25.31	29.38	33.48	37.79	42.40	47.07	51.47	55.37
G 79.0	4.74	7.55	10.90	14.67	18.68	22.77	26.81	30.89	35.15	39.65	44.18	48.46	52.31
G 80.0	2.88	5.52	8.79	12.44	16.33	20.30	24.23	28.22	32.40	36.83	41.31	45.56	49.38
G 81.0	1.68	3.90	6.80	10.22	13.97	17.85	21.72	25.66	29.78	34.15	38.55	42.71	46.45
G 82.0	1.03	2.60	4.95	8.06	11.71	15.57	19.40	23.27	27.29	31.53	35.81	39.90	43.62
G 83.0	0.47	1.34	3.09	5.92	9.50	13.35	17.11	20.83	24.67	28.74	32.88	36.91	40.65
G 84.0	0.29	0.84	2.16	4.49	7.58	11.07	14.66	18.33	22.15	26.14	30.18	34.10	37.78
G 85.0	0.09	0.31	1.23	3.13	5.82	9.00	12.42	16.02	19.77	23.66	27.57	31.38	34.98
G 86.0	0.00	0.00	0.31	1.80	4.12	7.01	10.24	13.73	17.45	21.33	25.22	28.97	32.46
G 87.0	0.05	0.00	0.31	1.28	2.87	5.06	7.79	11.03	14.73	18.81	22.95	26.81	30.13
G 88.0	0.17	0.14	0.33	0.83	1.76	3.28	5.49	8.41	12.03	16.24	20.59	24.54	27.73
G 89.0	0.27	0.28	0.34	0.44	0.85	1.96	4.02	6.90	10.40	14.27	18.16	21.70	24.66
G 90.0	0.57	0.63	0.50	0.25	0.24	0.92	3.64	7.90	13.31	19.51	26.14	32.87	39.41
G 91.0	0.19	0.23	0.12	0.17	0.22	0.27	1.88	4.31	7.24	10.37	13.65	17.10	20.70
G 92.0	0.13	0.16	0.11	0.49	0.88	1.26	3.49	6.53	9.88	13.13	16.34	19.69	23.29
G 93.0	0.09	0.09	0.10	0.16	0.71	2.25	5.10	8.76	12.55	15.95	19.12	22.41	26.05
G 94.0	0.10	0.10	0.09	0.74	2.03	4.17	7.26	10.94	14.74	18.30	21.73	25.26	29.03
G 95.0	0.09	0.09	0.09	1.29	3.31	6.10	9.55	13.37	17.22	20.85	24.38	28.02	31.88
G 96.0	0.17	0.22	0.27	2.04	4.78	8.17	11.92	15.84	19.73	23.48	27.17	30.94	34.86
G 97.0	0.06	0.34	1.43	3.63	6.72	10.40	14.35	18.39	22.36	26.16	29.90	33.74	37.78
G 98.0	0.58	1.47	3.12	5.66	8.94	12.72	16.79	20.95	25.02	28.87	32.64	36.54	40.70
G 99.0	1.13	2.70	4.94	7.80	11.19	15.02	19.17	23.46	27.67	31.66	35.54	39.49	43.60
G100.0	1.77	4.07	6.92	10.08	13.56	17.41	21.65	26.07	30.43	34.54	38.50	42.51	46.68
G101.0	3.19	5.90	9.06	12.40	15.97	19.89	24.23	28.76	33.20	37.35	41.33	45.38	49.61
G102.0	4.60	7.71	11.19	14.74	18.43	22.44	26.87	31.50	36.03	40.25	44.29	48.36	52.59
G103.0	6.67	9.89	13.42	17.06	20.88	25.02	29.57	34.29	38.91	43.20	47.30	51.41	55.66
G104.0	8.77	12.19	15.84	19.57	23.47	27.71	32.35	37.17	41.84	46.15	50.25	54.39	58.73
G105.0	10.89	14.43	18.17	21.99	26.00	30.35	35.11	40.04	44.78	49.09	53.17	57.32	61.73
G106.0	13.13	16.77	20.61	24.53	28.61	33.03	37.84	42.81	47.60	51.99	56.16	60.40	64.88
G107.0	15.43	19.20	23.18	27.21	31.39	35.85	40.66	45.60	50.38	54.80	59.01	63.27	67.75
G108.0	17.76	21.64	25.69	29.76	33.96	38.45	43.34	48.37	53.23	57.69	61.92	66.16	70.60
G109.0	20.19	24.10	28.20	32.36	36.67	41.28	46.25	51.34	56.24	60.73	64.96	69.20	73.62
G110.0	22.65	26.67	30.88	35.14	39.54	44.21	49.20	54.28	59.14	63.58	67.78	72.02	76.50
G111.0	25.19	29.27	33.52	37.80	42.21	46.91	51.96	57.12	62.05	66.51	70.70	74.92	79.36
G112.0	27.78	31.88	36.14	40.43	44.86	49.60	54.75	60.00	64.99	69.45	73.60	77.77	82.20
G113.0	30.47	34.64	38.97	43.32	47.80	52.56	57.66	62.85	67.80	72.28	76.48	80.71	85.17
G114.0	33.01	37.24	41.64	46.06	50.60	55.38	60.47	65.62	70.54	75.02	79.23	83.48	87.93
G115.0	35.71	39.98	44.38	48.77	53.27	58.07	63.26	68.56	73.56	78.02	82.16	86.32	90.73
G116.0	38.39	42.69	47.11	51.51	56.00	60.80	65.98	71.26	76.27	80.74	84.89	89.09	93.55
G117.0	41.03	45.42	49.93	54.42	58.97	63.75	68.86	74.05	78.99	83.46	87.64	91.83	96.21
G118.0	43.78	48.08	52.54	57.03	61.63	66.49	71.68	76.91	81.84	86.25	90.35	94.50	98.93
G119.0	46.59	50.92	55.38	59.82	64.37	69.19	74.36	79.61	84.57	88.99	93.09	97.22	101.59
G120.0	49.24	53.63	58.12	62.55	67.04	71.81	76.95	82.18	87.14	91.57	95.69	99.85	104.26
G121.0	52.00	56.35	60.82	65.27	69.80	74.59	79.74	84.96	89.88	94.27	98.34	102.43	106.78
G122.0	54.71	59.06	63.52	67.97	72.51	77.32	82.49	87.71	92.62	96.96	100.97	105.01	109.33
G123.0	57.38	61.79	66.28	70.69	75.16	79.90	85.04	90.28	95.20	99.53	103.52	107.54	111.84
G124.0	60.10	64.37	68.76	73.15	77.64	82.41	87.56	92.79	97.72	102.10	106.13	110.15	114.39
G125.0	62.89	67.18	71.53	75.82	80.21	84.93	90.12	95.44	100.42	104.77	108.73	112.69	116.91
G126.0	65.40	69.72	74.15	78.56	83.05	87.78	92.82	97.92	102.75	107.07	111.08	115.10	119.33
G127.0	68.11	72.35	76.73	81.14	85.66	90.41	95.45	100.53	105.31	109.57	113.53	117.50	121.70
G128.0	70.78	74.98	79.28	83.58	88.00	92.72	97.82	103.00	107.85	112.09	115.97	119.85	123.97
G129.0	73.37	77.60	81.94	86.23	90.60	95.24	100.23	105.30	110.07	114.29	118.19	122.14	126.36
G130.0	75.99	80.18	84.47	88.75	93.12	97.76	102.74	107.79	112.53	116.71	120.55	124.39	128.46
G131.0	78.63	82.80	87.09	91.36	95.71	100.31	105.24	110.24	114.94	119.10	122.93	126.77	130.83
G132.0	81.19	85.26	89.48	93.74	98.11	102.70	107.55	112.43	117.04	121.18	125.04	128.89	132.92
G133.0	83.73	87.83	92.04	96.24	100.52	105.04	109.87	114.75	119.35	123.44	127.22	130.99	134.96
G134.0	86.16	90.19	94.34	98.48	102.73	107.25	112.13	117.06	121.68	125.71	129.40	133.10	137.05
G135.0	88.72	92.77	96.92	101.02	105.20	109.64	114.42	119.28	123.84	127.84	131.51	135.19	139.10
G136.0	91.21	95.20	99.32	103.44	107.63	112.05	116.76	121.51	125.96	129.88	133.48	137.11	140.97
G137.0	93.64	97.52	101.53	105.55	109.68	114.06	118.76	123.51	128.00	131.98	135.64	139.25	143.02
G138.0	96.01	99.88	103.88	107.88	111.98	116.31	120.94	125.62	130.02	133.91	137.50	141.08	144.86
G139.0	98.46	102.33	106.27	110.15	114.09	118.31	122.92	127.62	132.03	135.88	139.39	142.86	146.53
G140.0	100.79	104.54	108.39	112.20	116.12	120.34	124.94	129.64	134.03	137.85	141.31	144.75	148.39
G141.0	103.12	106.92	110.80	114.64	118.53	122.66	127.12	131.64	135.90	139.64	143.08	146.49	150.07
G142.0	105.41	109.11	112.94	116.79	120.73	124.87	129.28	133.70	137.83	141.45	144.78	148.12	151.68
G143.0	107.64	111.33	115.13	118.88	122.69	126.72	131.03	135.39	139.50	143.13	146.46	149.76	153.22
G144.0	109.99	113.57	117.25	120.90	124.62	128.59	132.87	137.23	141.33	144.93	148.21	151.42	154.76
G145.0	112.21	115.68	119.27	122.86	126.56	130.49	134.72	139.00	143.01	146.53	149.72	152.85	156.12

LEDS C4⁺

Luminaire

Code PX-0525-ANT
Name KAPA

Measurement

Code PX-0525-ANT
Name KAPA

Luminaire Flux 443.60 lm Luminaire Power 10.30 W Efficacy 43.07 lm/W Efficiency 100.00%

Sources Flux 443.60 lm Maximum value 183.99 cd/klm Position C=175.00 G=159.00 CG Asymmetrical

Luminous Intensity Table cd/klm Table 9/18

	C 130.00	C 135.00	C 140.00	C 145.00	C 150.00	C 155.00	C 160.00	C 165.00	C 170.00	C 175.00	C 180.00	C 185.00	C 190.00
G 73.0	73.78	77.53	81.40	85.14	88.36	90.78	92.49	93.68	94.49	94.97	95.12	94.90	94.22
G 74.0	70.93	74.70	78.56	82.27	85.54	88.12	90.03	91.36	92.19	92.62	92.78	92.71	92.15
G 75.0	68.13	71.72	75.22	78.64	81.98	85.16	87.84	89.62	90.26	90.13	89.77	89.52	89.09
G 76.0	65.11	68.74	72.27	75.73	79.10	82.31	84.99	86.73	87.28	87.04	86.59	86.34	85.95
G 77.0	62.10	65.85	69.73	73.56	77.08	80.03	82.24	83.54	83.87	83.60	83.18	82.92	82.52
G 78.0	58.99	62.65	66.56	70.47	74.04	76.95	79.06	80.27	80.55	80.26	79.85	79.61	79.24
G 79.0	55.92	59.57	63.45	67.30	70.78	73.58	75.59	76.73	77.00	76.76	76.41	76.23	75.90
G 80.0	52.98	56.64	60.52	64.34	67.71	70.30	72.05	72.97	73.14	72.87	72.57	72.49	72.30
G 81.0	49.99	53.62	57.51	61.32	64.55	66.84	68.23	68.89	69.00	68.80	68.56	68.44	68.18
G 82.0	47.10	50.56	54.09	57.50	60.45	62.72	64.28	65.18	65.48	65.42	65.26	65.16	64.86
G 83.0	44.17	47.56	50.87	54.01	56.82	59.17	60.94	62.02	62.39	62.30	62.07	61.92	61.58
G 84.0	41.26	44.60	47.86	50.94	53.71	56.04	57.81	58.92	59.32	59.24	59.01	58.82	58.43
G 85.0	38.41	41.71	44.90	47.91	50.63	52.95	54.77	55.99	56.56	56.67	56.54	56.31	55.79
G 86.0	35.74	38.93	42.09	45.14	47.96	50.41	52.31	53.50	53.89	53.74	53.45	53.25	52.88
G 87.0	33.12	36.12	39.32	42.54	45.45	47.81	49.50	50.45	50.68	50.47	50.17	49.99	49.67
G 88.0	30.45	33.19	36.27	39.44	42.34	44.63	46.23	47.14	47.39	47.23	46.97	46.78	46.43
G 89.0	27.30	30.03	33.11	36.29	39.17	41.43	43.00	43.89	44.15	44.01	43.75	43.56	43.20
G 90.0	24.27	27.02	30.59	33.30	35.87	38.39	40.63	42.30	43.20	43.56	43.75	44.01	44.15
G 91.0	26.97	30.45	33.55	36.35	39.01	41.59	43.86	45.54	46.43	46.78	46.97	47.23	47.39
G 92.0	29.82	33.42	36.60	39.46	42.17	44.79	47.11	48.80	49.67	49.99	50.17	50.47	50.68
G 93.0	32.83	36.41	39.55	42.38	45.07	47.76	50.16	51.94	52.88	53.25	53.45	53.74	53.89
G 94.0	35.76	39.34	42.41	45.11	47.71	50.35	52.79	54.68	55.79	56.31	56.54	56.67	56.56
G 95.0	38.75	42.37	45.52	48.33	50.97	53.54	55.82	57.51	58.43	58.82	59.01	59.24	59.32
G 96.0	41.80	45.50	48.66	51.43	54.04	56.63	58.96	60.68	61.58	61.92	62.07	62.30	62.39
G 97.0	44.85	48.65	51.87	54.66	57.28	59.88	62.23	63.96	64.86	65.16	65.26	65.42	65.48
G 98.0	47.73	51.65	55.17	58.32	61.17	63.76	65.91	67.42	68.18	68.44	68.56	68.80	69.00
G100.0	50.85	54.80	58.35	61.57	64.57	67.41	69.83	71.52	72.30	72.49	72.57	72.87	73.14
G101.0	53.86	57.86	61.42	64.63	67.66	70.58	73.14	74.98	75.90	76.23	76.41	76.76	77.00
G102.0	56.85	60.89	64.55	67.88	71.00	73.94	76.48	78.30	79.24	79.61	79.85	80.26	80.55
G103.0	59.90	63.92	67.56	70.88	74.02	77.02	79.64	81.54	82.52	82.92	83.18	83.60	83.87
G104.0	63.08	67.15	70.75	73.99	77.09	80.17	82.92	84.93	85.95	86.34	86.59	87.04	87.28
G105.0	66.17	70.28	73.82	76.98	80.01	83.09	85.90	87.99	89.09	89.52	89.77	90.13	90.26
G106.0	69.31	73.30	76.60	79.48	82.34	85.44	88.42	90.78	92.15	92.71	92.78	92.62	92.19
G107.0	72.19	76.29	79.80	82.86	85.69	88.44	90.93	92.92	94.22	94.90	95.12	94.97	94.49
G108.0	75.04	79.20	82.86	86.09	89.02	91.72	94.01	95.64	96.49	96.84	97.11	97.57	97.87
G109.0	78.01	82.10	85.67	88.86	91.90	94.90	97.54	99.41	100.23	100.39	100.44	100.74	100.95
G110.0	80.98	85.10	88.63	91.73	94.66	97.60	100.26	102.28	103.40	103.86	104.02	104.11	103.96
G111.0	83.80	87.91	91.45	94.58	97.51	100.40	103.00	104.99	106.13	106.62	106.75	106.75	106.48
G112.0	86.63	90.74	94.26	97.36	100.29	103.18	105.80	107.78	108.89	109.34	109.43	109.41	109.14
G113.0	89.60	93.66	97.11	100.13	102.98	105.83	108.43	110.38	111.42	111.79	111.86	111.88	111.69
G114.0	92.37	96.43	99.90	102.93	105.80	108.67	111.27	113.24	114.33	114.74	114.80	114.76	114.48
G115.0	95.15	99.19	102.61	105.59	108.43	111.32	113.95	115.90	116.90	117.22	117.25	117.30	117.18
G116.0	98.00	102.07	105.46	108.37	111.10	113.84	116.35	118.27	119.35	119.80	119.95	120.02	119.86
G117.0	100.57	104.58	108.02	111.03	113.82	116.53	118.95	120.78	121.80	122.24	122.41	122.52	122.40
G118.0	103.36	107.42	110.83	113.75	116.47	119.16	121.60	123.47	124.54	125.01	125.16	125.21	125.00
G119.0	105.96	109.99	113.41	116.37	119.11	121.78	124.16	125.96	126.98	127.40	127.53	127.57	127.36
G120.0	108.67	112.69	116.06	118.95	121.66	124.36	126.82	128.66	129.66	130.03	130.10	130.12	129.92
G121.0	111.14	115.15	118.54	121.47	124.20	126.89	129.31	131.13	132.14	132.54	132.63	132.64	132.43
G122.0	113.67	117.68	121.07	124.01	126.75	129.45	131.86	133.66	134.60	134.93	134.99	135.02	134.86
G123.0	116.17	120.16	123.54	126.46	129.16	131.82	134.20	135.98	136.94	137.29	137.36	137.36	137.17
G124.0	118.64	122.56	125.95	128.91	131.65	134.31	136.66	138.42	139.39	139.76	139.81	139.76	139.47
G125.0	121.17	125.11	128.48	131.40	134.08	136.65	138.91	140.59	141.49	141.84	141.94	142.00	141.85
G126.0	123.56	127.45	130.77	133.66	136.35	138.98	141.33	143.10	144.08	144.45	144.48	144.37	144.03
G127.0	125.90	129.77	133.06	135.92	138.58	141.19	143.52	145.27	146.23	146.57	146.62	146.58	146.31
G128.0	128.13	131.97	135.28	138.16	140.85	143.48	145.80	147.51	148.40	148.68	148.70	148.70	148.51
G129.0	130.58	134.41	137.58	140.29	142.85	145.49	147.91	149.73	150.69	150.97	150.91	150.75	150.40
G130.0	132.56	136.35	139.60	142.45	145.12	147.73	150.06	151.80	152.75	153.09	153.11	153.02	152.69
G131.0	134.89	138.62	141.79	144.54	147.11	149.65	151.92	153.62	154.51	154.82	154.83	154.78	154.52
G132.0	136.92	140.61	143.77	146.55	149.17	151.75	154.08	155.82	156.75	157.03	156.95	156.71	156.24
G133.0	138.93	142.61	145.80	148.61	151.21	153.71	155.93	157.59	158.51	158.85	158.87	158.75	158.39
G134.0	141.03	144.69	147.81	150.52	153.06	155.58	157.84	159.50	160.33	160.55	160.49	160.38	160.09
G135.0	143.02	146.64	149.70	152.37	154.88	157.39	159.65	161.36	162.27	162.54	162.40	162.05	161.49
G136.0	144.85	148.45	151.53	154.22	156.73	159.19	161.40	163.05	163.94	164.25	164.23	164.08	163.70
G137.0	146.77	150.27	153.34	156.06	158.56	160.94	163.02	164.54	165.36	165.62	165.57	165.39	164.99
G138.0	148.65	152.12	155.07	157.63	160.02	162.36	164.49	166.12	167.06	167.43	167.38	167.07	166.50
G139.0	150.23	153.69	156.72	159.39	161.86	164.20	166.27	167.81	168.70	169.04	168.96	168.89	168.46
G140.0	152.06	155.46	158.38	160.93	163.31	165.64	167.71	169.24	170.05	170.29	170.24	170.08	169.74
G141.0	153.67	156.99	159.85	162.37	164.71	167.00	169.05	170.58	171.42	171.71	171.68	171.48	171.08
G142.0	155.26	158.56	161.38	163.84	166.17	168.49	170.59	172.16	173.00	173.25	173.14	172.84	172.33
G143.0	156.69	159.97	162.87	165.45	167.79	169.95	171.79	173.15	173.90	174.17	174.15	173.97	173.56
G144.0	158.10	161.23	164.02	166.52	168.88	171.15	173.14	174.61	175.37	175.57	175.43	175.13	174.61
G145.0	159.41	162.55	165.40	167.97	170.32	172.48	174.31	175.63	176.32	176.54	176.49	176.31	175.91

LEDS C4⁺

Luminaire

Code PX-0525-ANT
Name KAPA

Measurerm.

Code PX-0525-ANT
Name KAPA

Luminaire Flux	443.60 lm	Luminaire Power	10.30 W	Efficacy	43.07 lm/W	Efficiency	100.00%
Sources Flux	443.60 lm	Maximum value	183.99 cd/klm	Position	C=175.00 G=159.00	CG	Asymmetrical

Luminous Intensity Table cd/klm Table 10/18

	C 195.00	C 200.00	C 205.00	C 210.00	C 215.00	C 220.00	C 225.00	C 230.00	C 235.00	C 240.00	C 245.00	C 250.00	C 255.00
G 73.0	92.92	90.93	88.44	85.69	82.86	79.80	76.29	72.19	67.75	63.27	59.01	54.80	50.38
G 74.0	90.78	88.42	85.44	82.34	79.48	76.60	73.30	69.31	64.88	60.40	56.16	51.99	47.60
G 75.0	87.99	85.90	83.09	80.01	76.98	73.82	70.28	66.17	61.73	57.32	53.17	49.09	44.78
G 76.0	84.93	82.92	80.17	77.09	73.99	70.75	67.15	63.08	58.73	54.39	50.25	46.15	41.84
G 77.0	81.54	79.64	77.02	74.02	70.88	67.56	63.92	59.90	55.66	51.41	47.30	43.20	38.91
G 78.0	78.30	76.48	73.94	71.00	67.88	64.55	60.89	56.85	52.59	48.36	44.29	40.25	36.03
G 79.0	74.98	73.14	70.58	67.66	64.63	61.42	57.86	53.86	49.61	45.38	41.33	37.35	33.20
G 80.0	71.52	69.83	67.41	64.57	61.57	58.35	54.80	50.85	46.68	42.51	38.50	34.54	30.43
G 81.0	67.42	65.91	63.76	61.17	58.32	55.17	51.65	47.73	43.60	39.49	35.54	31.66	27.67
G 82.0	63.96	62.23	59.88	57.28	54.66	51.87	48.65	44.85	40.70	36.54	32.64	28.87	25.02
G 83.0	60.68	58.96	56.63	54.04	51.43	48.66	45.50	41.80	37.78	33.74	29.90	26.16	22.36
G 84.0	57.51	55.82	53.54	50.97	48.33	45.52	42.37	38.75	34.86	30.94	27.17	23.48	19.73
G 85.0	54.68	52.79	50.35	47.71	45.11	42.41	39.34	35.76	31.88	28.02	24.38	20.85	17.22
G 86.0	51.94	50.16	47.76	45.07	42.38	39.55	36.41	32.83	29.03	25.26	21.73	18.30	14.74
G 87.0	48.80	47.11	44.79	42.17	39.46	36.60	33.42	29.82	26.05	22.41	19.12	15.95	12.55
G 88.0	45.54	43.86	41.59	39.01	36.35	33.55	30.45	26.97	23.29	19.69	16.34	13.13	9.88
G 89.0	42.30	40.63	38.39	35.87	33.30	30.59	27.62	24.27	20.70	17.10	13.65	10.37	7.24
G 90.0	39.05	37.39	35.15	32.63	30.11	27.45	24.44	21.19	17.70	14.29	10.96	7.84	4.91
G 91.0	35.80	34.14	31.90	29.38	26.86	24.20	21.19	17.94	14.54	11.24	8.03	5.12	2.61
G 92.0	32.55	30.89	28.65	26.16	23.64	21.00	17.99	14.78	11.57	8.37	5.36	2.95	0.44
G 93.0	29.30	27.64	25.40	22.97	20.45	18.30	15.29	12.08	8.87	5.76	2.95	0.44	
G 94.0	26.05	24.39	22.15	20.28	18.16	16.11	13.10	10.00	6.89	4.18	1.57	0.06	
G 95.0	22.80	21.14	18.90	17.59	15.43	13.26	10.29	7.48	4.67	2.16	0.06		
G 96.0	19.55	17.89	15.65	14.70	12.81	10.94	8.13	5.52	2.85	0.35			
G 97.0	16.30	14.64	12.40	11.81	10.05	8.20	5.59	3.12	0.64				
G 98.0	13.05	11.39	9.15	9.22	7.56	5.81	3.44	0.96					
G 99.0	9.80	8.14	5.90	6.17	4.82	3.63	2.00	0.30					
G100.0	6.55	4.89	2.65	3.52	2.48	1.82	0.84	0.18					
G101.0	3.30	1.64	0.40	1.27	0.93	0.74	0.36	0.08					
G102.0	0.05	0.00	0.00	0.00	0.00	0.00	0.00	0.00					
G103.0													
G104.0													
G105.0													
G106.0													
G107.0													
G108.0													
G109.0													
G110.0													
G111.0													
G112.0													
G113.0													
G114.0													
G115.0													
G116.0													
G117.0													
G118.0													
G119.0													
G120.0													
G121.0													
G122.0													
G123.0													
G124.0													
G125.0													
G126.0													
G127.0													
G128.0													
G129.0													
G130.0													
G131.0													
G132.0													
G133.0													
G134.0													
G135.0													
G136.0													
G137.0													
G138.0													
G139.0													
G140.0													
G141.0													
G142.0													
G143.0													
G144.0													
G145.0													

LEDS C4⁺

Luminaire

Code PX-0525-ANT
Name KAPA

Measurement

Code PX-0525-ANT
Name KAPA

Luminaire Flux	443.60 lm	Luminaire Power	10.30 W	Efficacy	43.07 lm/W	Efficiency	100.00%
Sources Flux	443.60 lm	Maximum value	183.99 cd/klm	Position	C=175.00 G=159.00	CG	Asymmetrical

Luminous Intensity Table cd/klm Table 11/18

	C 260.00	C 265.00	C 270.00	C 275.00	C 280.00	C 285.00	C 290.00	C 295.00	C 300.00	C 305.00	C 310.00	C 315.00	C 320.00
G 73.0	45.60	40.66	35.85	31.39	27.21	23.18	19.20	15.43	12.05	9.23	6.90	4.92	3.23
G 74.0	42.81	37.84	33.03	28.61	24.53	20.61	16.77	13.13	9.87	7.14	4.94	3.24	2.00
G 75.0	40.04	35.11	30.35	26.00	21.99	18.17	14.43	10.89	7.74	5.13	3.12	1.75	1.00
G 76.0	37.17	32.35	27.71	23.47	19.57	15.84	12.19	8.77	5.79	3.43	1.74	0.74	0.74
G 77.0	34.29	29.57	25.02	20.88	17.06	13.42	9.89	6.67	4.03	2.18	1.05	0.50	0.39
G 78.0	31.50	26.87	22.44	18.43	14.74	11.19	7.71	4.60	2.27	0.98	0.51	0.47	0.56
G 79.0	28.76	24.23	19.89	15.97	12.40	9.06	5.90	3.19	1.29	1.03	0.76	0.49	0.66
G 80.0	26.07	21.65	17.41	13.56	10.08	6.92	4.07	1.77	0.31	0.38	0.44	0.51	0.58
G 81.0	23.46	19.17	15.02	11.19	7.80	4.94	2.70	1.13	0.25	0.34	0.43	0.52	0.56
G 82.0	20.95	16.79	12.72	8.94	5.66	3.12	1.47	0.58	0.22	0.31	0.39	0.48	0.49
G 83.0	18.39	14.35	10.40	6.72	3.63	1.43	0.34	0.06	0.15	0.27	0.36	0.41	0.44
G 84.0	15.84	11.92	8.17	4.78	2.04	0.27	0.22	0.17	0.12	0.34	0.39	0.39	0.41
G 85.0	13.37	9.55	6.10	3.31	1.29	0.09	0.09	0.09	0.10	0.27	0.33	0.37	0.44
G 86.0	10.94	7.26	4.17	2.03	0.74	0.09	0.10	0.10	0.11	0.24	0.33	0.42	0.53
G 87.0	8.76	5.10	2.25	0.71	0.16	0.10	0.09	0.09	0.12	0.22	0.36	0.51	0.66
G 88.0	6.53	3.49	1.26	0.88	0.49	0.11	0.16	0.13	0.14	0.24	0.41	0.61	0.78
G 89.0	4.31	1.88	0.27	0.22	0.17	0.12	0.23	0.19	0.16	0.27	0.47	0.70	0.91
G 90.0	7.90	3.64	0.92	0.24	0.25	0.50	0.63	0.57	0.63	1.02	1.59	2.07	2.30
G 91.0	6.90	4.02	1.96	0.85	0.44	0.34	0.28	0.27	0.37	0.64	0.94	1.11	1.07
G 92.0	8.41	5.49	3.28	1.76	0.83	0.33	0.14	0.17	0.36	0.61	0.83	0.91	0.81
G 93.0	11.03	7.79	5.06	2.87	1.28	0.31	0.00	0.05	0.29	0.37	0.45	0.53	0.49
G 94.0	13.73	10.24	7.01	4.12	1.80	0.31	0.00	0.00	0.22	0.28	0.33	0.38	0.35
G 95.0	16.02	12.42	9.00	5.82	3.13	1.23	0.31	0.09	0.18	0.26	0.27	0.23	0.24
G 96.0	18.33	14.66	11.07	7.58	4.49	2.16	0.84	0.29	0.17	0.18	0.21	0.22	0.22
G 97.0	20.83	17.11	13.35	9.50	5.92	3.09	1.34	0.47	0.16	0.10	0.15	0.20	0.20
G 98.0	23.27	19.40	15.57	11.71	8.06	4.95	2.60	1.03	0.16	0.00	0.01	0.19	0.19
G 99.0	25.66	21.72	17.85	13.97	10.22	6.80	3.90	1.68	0.30	0.26	0.22	0.18	0.23
G100.0	28.22	24.23	20.30	16.33	12.44	8.79	5.52	2.88	1.08	0.78	0.47	0.17	0.15
G101.0	30.89	26.81	22.77	18.68	14.67	10.90	7.55	4.74	2.63	1.28	0.53	0.15	0.00
G102.0	33.48	29.38	25.31	21.15	17.04	13.15	9.66	6.65	4.18	2.30	0.98	0.17	0.00
G103.0	36.21	32.03	27.85	23.57	19.33	15.36	11.83	8.71	5.97	3.57	1.64	0.34	0.00
G104.0	39.06	34.79	30.51	26.13	21.81	17.75	14.11	10.88	7.97	5.34	3.11	1.44	0.43
G105.0	41.69	37.38	33.06	28.66	24.31	20.21	16.52	13.17	10.07	7.15	4.58	2.54	1.20
G106.0	44.53	40.18	35.81	31.32	26.85	22.63	18.81	15.36	12.18	9.23	6.56	4.28	2.47
G107.0	47.35	42.98	38.57	34.00	29.44	25.13	21.23	17.70	14.42	11.32	8.47	6.01	4.05
G108.0	49.94	45.58	41.19	36.63	32.06	27.72	23.79	20.20	16.81	13.55	10.54	7.97	5.96
G109.0	52.87	48.42	43.94	39.31	34.69	30.30	26.31	22.64	19.14	15.75	12.62	9.97	7.96
G110.0	55.69	51.20	46.65	41.95	37.25	32.81	28.78	25.08	21.55	18.09	14.88	12.14	10.06
G111.0	58.38	53.91	49.39	44.70	40.01	35.55	31.50	27.75	24.14	20.58	17.26	14.45	12.33
G112.0	61.22	56.75	52.21	47.47	42.71	38.19	34.07	30.26	26.59	22.95	19.57	16.71	14.58
G113.0	63.97	59.51	54.95	50.18	45.37	40.80	36.66	32.84	29.15	25.50	22.08	19.17	16.95
G114.0	66.61	62.10	57.55	52.84	48.12	43.60	39.43	35.54	31.78	28.10	24.68	21.75	19.48
G115.0	69.39	64.85	60.27	55.55	50.83	46.31	42.12	38.19	34.41	30.71	27.26	24.31	22.00
G116.0	72.09	67.59	63.04	58.30	53.54	48.96	44.72	40.77	37.00	33.34	29.94	26.99	24.60
G117.0	74.84	70.30	65.72	61.00	56.28	51.72	47.47	43.48	39.69	36.07	32.71	29.77	27.33
G118.0	77.39	72.89	68.36	63.68	58.97	54.42	50.17	46.18	42.39	38.76	35.39	32.42	29.93
G119.0	80.09	75.68	71.18	66.45	61.64	57.02	52.76	48.83	45.09	41.47	38.07	35.06	32.53
G120.0	82.69	78.20	73.67	69.00	64.31	59.79	55.58	51.64	47.90	44.32	40.96	37.95	35.34
G121.0	85.21	80.76	76.29	71.65	66.98	62.48	58.30	54.39	50.66	47.03	43.63	40.57	37.96
G122.0	87.94	83.38	78.80	74.14	69.52	65.10	61.00	57.15	53.42	49.76	46.28	43.18	40.56
G123.0	90.35	85.84	81.33	76.71	72.12	67.72	63.65	59.84	56.16	52.55	49.12	46.01	43.34
G124.0	92.81	88.24	83.71	79.16	74.69	70.41	66.41	62.62	58.93	55.25	51.75	48.60	45.93
G125.0	95.40	90.96	86.48	81.87	77.28	72.90	68.90	65.16	61.54	57.92	54.45	51.30	48.62
G126.0	97.74	93.35	88.95	84.41	79.88	75.54	71.56	67.84	64.24	60.65	57.20	54.07	51.36
G127.0	100.20	95.82	91.42	86.91	82.42	78.14	74.18	70.47	66.84	63.21	59.73	56.59	53.96
G128.0	102.59	98.22	93.83	89.34	84.87	80.61	76.69	73.01	69.43	65.86	62.43	59.33	56.68
G129.0	105.01	100.72	96.37	91.87	87.36	83.09	79.20	75.60	72.09	68.55	65.13	62.03	59.38
G130.0	107.34	103.01	98.66	94.21	89.78	85.56	81.69	78.07	74.55	71.03	67.66	64.61	62.01
G131.0	109.53	105.26	100.98	96.57	92.18	88.01	84.18	80.60	77.11	73.61	70.24	67.20	64.62
G132.0	111.82	107.65	103.43	99.06	94.67	90.47	86.63	83.05	79.60	76.18	72.90	69.90	67.31
G133.0	114.27	110.00	105.72	101.36	97.06	92.97	89.21	85.67	82.22	78.76	75.43	72.44	69.92
G134.0	116.29	112.14	107.96	103.67	99.40	95.32	91.56	88.04	84.62	81.20	77.93	74.98	72.48
G135.0	118.62	114.38	110.16	105.93	101.76	97.76	94.03	90.50	87.08	83.71	80.51	77.62	75.12
G136.0	120.44	116.33	112.24	108.13	104.06	100.16	96.50	93.02	89.63	86.26	83.04	80.15	77.70
G137.0	122.56	118.64	114.67	110.52	106.34	102.36	98.72	95.34	92.05	88.74	85.54	82.66	80.23
G138.0	124.68	120.71	116.73	112.62	108.52	104.61	101.01	97.63	94.35	91.07	87.93	85.11	82.74
G139.0	126.68	122.82	118.92	114.86	110.79	106.92	103.41	100.14	96.94	93.69	90.55	87.71	85.33
G140.0	128.55	124.66	120.77	116.82	112.91	109.18	105.74	102.49	99.29	96.06	92.94	90.14	87.81
G141.0	130.68	126.73	122.80	118.91	115.08	111.41	107.93	104.61	101.41	98.30	95.36	92.68	90.35
G142.0	132.34	128.47	124.64	120.84	117.11	113.56	110.23	107.06	103.93	100.78	97.75	95.04	92.76
G143.0	134.21	130.45	126.69	122.89	119.15	115.59	112.30	109.19	106.15	103.09	100.15	97.51	95.29
G144.0	135.95	132.29	128.64	124.92	121.22	117.69	114.44	111.38	108.39	105.39	102.52	99.93	97.75
G145.0	137.88	134.19	130.50	126.82	123.21	119.79	116.62	113.63	110.68	107.71	104.85	102.28	100.12

LEDS C4⁺

Luminaire

Code PX-0525-ANT
Name KAPA

Measurerm.

Code PX-0525-ANT
Name KAPA

Luminaire Flux	443.60 lm	Luminaire Power	10.30 W	Efficacy	43.07 lm/W	Efficiency	100.00%
Sources Flux	443.60 lm	Maximum value	183.99 cd/klm	Position	C=175.00 G=159.00	CG	Asymmetrical

Luminous Intensity Table cd/klm Table 12/18

	C 325.00	C 330.00	C 335.00	C 340.00	C 345.00	C 350.00	C 355.00
G 73.0	1.90	1.05	1.02	0.99	0.96	1.11	1.19
G 74.0	1.19	0.77	0.67	0.78	0.96	1.09	1.17
G 75.0	0.73	0.71	0.78	0.88	0.99	1.09	1.17
G 76.0	0.74	0.74	0.90	0.96	1.01	1.08	1.17
G 77.0	0.55	0.77	0.91	0.99	1.04	1.11	1.20
G 78.0	0.68	0.80	0.88	0.94	1.00	1.07	1.15
G 79.0	0.74	0.79	0.82	0.85	0.89	0.95	1.02
G 80.0	0.65	0.73	0.74	0.76	0.77	0.82	0.88
G 81.0	0.59	0.63	0.64	0.66	0.67	0.72	0.77
G 82.0	0.50	0.51	0.53	0.60	0.67	0.74	0.79
G 83.0	0.46	0.50	0.57	0.65	0.73	0.80	0.87
G 84.0	0.47	0.55	0.63	0.72	0.80	0.88	0.95
G 85.0	0.54	0.64	0.74	0.82	0.90	0.96	1.02
G 86.0	0.66	0.78	0.87	0.95	1.02	1.06	1.10
G 87.0	0.79	0.91	1.01	1.11	1.19	1.24	1.28
G 88.0	0.93	1.07	1.19	1.29	1.38	1.44	1.49
G 89.0	1.08	1.23	1.36	1.48	1.57	1.64	1.69
G 90.0	2.38	2.52	2.85	3.27	3.62	3.79	3.81
G 91.0	0.93	0.92	1.16	1.53	1.84	1.94	1.88
G 92.0	0.66	0.66	0.94	1.35	1.68	1.79	1.70
G 93.0	0.45	0.41	0.73	1.17	1.51	1.60	1.51
G 94.0	0.31	0.28	0.59	0.99	1.31	1.40	1.31
G 95.0	0.24	0.25	0.53	0.87	1.15	1.24	1.20
G 96.0	0.22	0.23	0.48	0.80	1.06	1.16	1.12
G 97.0	0.20	0.21	0.43	0.73	0.97	1.06	1.02
G 98.0	0.19	0.19	0.40	0.69	0.93	1.01	0.96
G 99.0	0.16	0.17	0.38	0.70	0.95	1.03	0.96
G100.0	0.10	0.16	0.45	0.82	1.12	1.20	1.11
G101.0	0.00	0.14	0.53	0.97	1.30	1.39	1.29
G102.0	0.00	0.11	0.59	1.10	1.47	1.56	1.45
G103.0	0.00	0.10	0.63	1.16	1.54	1.64	1.52
G104.0	0.01	0.09	0.52	1.07	1.51	1.64	1.52
G105.0	0.50	0.35	0.63	1.09	1.48	1.59	1.48
G106.0	1.23	0.62	0.90	1.17	1.45	1.57	1.46
G107.0	2.62	1.75	1.68	1.60	1.52	1.43	1.34
G108.0	4.48	3.41	2.66	2.16	1.83	1.62	1.48
G109.0	6.46	5.28	4.27	3.44	2.84	2.52	2.39
G110.0	8.48	7.22	6.10	5.14	4.40	3.90	3.58
G111.0	10.73	9.37	8.06	6.88	5.95	5.39	5.09
G112.0	12.96	11.56	10.15	8.84	7.80	7.18	6.86
G113.0	15.24	13.73	12.23	10.84	9.75	9.10	8.78
G114.0	17.68	16.07	14.44	12.94	11.76	11.06	10.73
G115.0	20.15	18.47	16.77	15.18	13.95	13.22	12.87
G116.0	22.63	20.84	19.08	17.47	16.23	15.49	15.13
G117.0	25.25	23.34	21.47	19.79	18.49	17.73	17.38
G118.0	27.81	25.86	23.96	22.26	20.95	20.18	19.80
G119.0	30.36	28.37	26.45	24.75	23.44	22.67	22.30
G120.0	33.06	30.97	28.98	27.24	25.92	25.15	24.79
G121.0	35.70	33.61	31.62	29.85	28.50	27.70	27.31
G122.0	38.31	36.24	34.24	32.45	31.09	30.30	29.94
G123.0	41.00	38.86	36.82	35.03	33.68	32.89	32.53
G124.0	43.64	41.55	39.53	37.74	36.38	35.58	35.21
G125.0	46.30	44.19	42.20	40.46	39.14	38.36	37.98
G126.0	49.01	46.87	44.85	43.10	41.77	41.00	40.64
G127.0	51.70	49.63	47.63	45.85	44.49	43.69	43.31
G128.0	54.39	52.31	50.33	48.58	47.26	46.48	46.10
G129.0	57.10	55.02	53.04	51.29	49.96	49.19	48.84
G130.0	59.77	57.72	55.76	54.03	52.72	51.94	51.57
G131.0	62.41	60.40	58.48	56.78	55.49	54.72	54.35
G132.0	65.05	62.99	61.07	59.40	58.15	57.42	57.08
G133.0	67.76	65.78	63.89	62.20	60.91	60.14	59.77
G134.0	70.33	68.39	66.54	64.91	63.67	62.92	62.54
G135.0	72.95	70.98	69.14	67.53	66.32	65.62	65.29
G136.0	75.59	73.67	71.83	70.20	68.97	68.25	67.92
G137.0	78.15	76.28	74.50	72.93	71.74	71.04	70.70
G138.0	80.71	78.86	77.08	75.51	74.32	73.64	73.35
G139.0	83.30	81.47	79.71	78.17	77.00	76.32	76.02
G140.0	85.84	84.06	82.34	80.81	79.66	79.01	78.74
G141.0	88.31	86.47	84.80	83.37	82.32	81.72	81.45
G142.0	90.82	89.09	87.44	86.00	84.89	84.23	83.89
G143.0	93.40	91.68	90.04	88.58	87.48	86.83	86.52
G144.0	95.89	94.19	92.55	91.11	90.02	89.41	89.15
G145.0	98.29	96.64	95.08	93.70	92.66	92.04	91.73

LEDS C4⁺

Luminaire

Code PX-0525-ANT
Name KAPA

Measurement

Code PX-0525-ANT
Name KAPA

Luminaire Flux	443.60 lm	Luminaire Power	10.30 W	Efficacy	43.07 lm/W	Efficiency	100.00%
Sources Flux	443.60 lm	Maximum value	183.99 cd/klm	Position	C=175.00 G=159.00	CG	Asymmetrical

Luminous Intensity Table cd/klm Table 13/18

	C 0.00	C 5.00	C 10.00	C 15.00	C 20.00	C 25.00	C 30.00	C 35.00	C 40.00	C 45.00	C 50.00	C 55.00	C 60.00
G146.0	94.10	93.80	93.65	93.83	94.47	95.57	97.10	99.02	101.21	103.53	105.91	108.44	111.26
G147.0	96.74	96.43	96.26	96.39	96.92	97.92	99.38	101.31	103.54	105.89	108.22	110.67	113.42
G148.0	99.24	98.83	98.59	98.71	99.31	100.38	101.88	103.76	105.90	108.19	110.53	113.01	115.74
G149.0	101.78	101.47	101.30	101.43	101.97	102.94	104.35	106.15	108.23	110.46	112.73	115.13	117.78
G150.0	104.37	103.94	103.66	103.71	104.21	105.18	106.61	108.47	110.61	112.88	115.15	117.50	120.06
G151.0	106.79	106.37	106.13	106.23	106.80	107.82	109.23	110.95	112.90	114.98	117.13	119.43	121.99
G152.0	109.15	108.74	108.51	108.61	109.18	110.21	111.65	113.43	115.43	117.51	119.57	121.72	124.12
G153.0	111.72	111.39	111.18	111.22	111.62	112.43	113.70	115.42	117.45	119.57	121.66	123.80	126.15
G154.0	114.16	113.66	113.35	113.39	113.93	114.92	116.26	117.88	119.70	121.65	123.68	125.85	128.26
G155.0	116.44	116.09	115.87	115.90	116.31	117.14	118.41	120.12	122.08	124.08	125.97	127.88	130.01
G156.0	118.82	118.49	118.30	118.34	118.74	119.54	120.74	122.36	124.23	126.17	128.05	129.97	132.06
G157.0	121.22	120.85	120.62	120.67	121.10	121.92	123.08	124.54	126.21	128.02	129.90	131.89	134.05
G158.0	123.46	123.15	122.95	123.01	123.41	124.18	125.33	126.83	128.56	130.35	132.10	133.89	135.85
G159.0	125.81	125.57	125.42	125.46	125.78	126.44	127.48	128.90	130.56	132.27	133.91	135.61	137.53
G160.0	128.15	127.72	127.43	127.43	127.82	128.58	129.68	131.03	132.57	134.21	135.88	137.64	139.56
G161.0	130.37	130.03	129.82	129.84	130.19	130.87	131.88	133.16	134.63	136.18	137.73	139.35	141.15
G162.0	132.65	132.29	132.03	131.98	132.22	132.81	133.75	135.05	136.56	138.11	139.58	141.07	142.74
G163.0	134.85	134.38	134.05	134.02	134.40	135.14	136.15	137.37	138.71	140.12	141.54	143.02	144.63
G164.0	136.94	136.62	136.39	136.34	136.55	137.06	137.92	139.13	140.55	141.99	143.32	144.63	146.06
G165.0	139.22	138.84	138.55	138.46	138.65	139.14	139.94	141.04	142.34	143.68	144.98	146.30	147.75
G166.0	141.28	140.81	140.46	140.36	140.61	141.17	142.01	143.06	144.24	145.50	146.76	148.06	149.43
G167.0	143.34	143.10	142.92	142.85	142.96	143.29	143.91	144.84	145.98	147.19	148.36	149.54	150.81
G168.0	145.62	145.14	144.75	144.57	144.69	145.10	145.80	146.77	147.90	149.05	150.14	151.22	152.35
G169.0	147.55	147.15	146.85	146.73	146.86	147.22	147.79	148.54	149.42	150.40	151.45	152.56	153.70
G170.0	149.56	149.11	148.76	148.59	148.67	149.00	149.57	150.32	151.21	152.14	153.06	154.00	155.01
G171.0	151.51	151.19	150.92	150.77	150.77	150.96	151.36	151.98	152.76	153.64	154.57	155.53	156.49
G172.0	153.49	153.03	152.67	152.50	152.58	152.88	153.30	153.79	154.37	155.04	155.84	156.70	157.59
G173.0	155.28	154.86	154.51	154.29	154.25	154.40	154.74	155.25	155.87	156.53	157.19	157.86	158.59
G174.0	157.09	156.65	156.26	156.01	155.93	156.04	156.34	156.81	157.40	158.03	158.64	159.25	159.88
G175.0	158.98	158.41	157.95	157.69	157.71	157.93	158.23	158.54	158.87	159.27	159.77	160.32	160.89
G176.0	160.57	160.14	159.75	159.44	159.25	159.22	159.37	159.73	160.20	160.68	161.08	161.44	161.80
G177.0	162.35	161.85	161.41	161.11	160.99	161.02	161.15	161.34	161.56	161.82	162.08	162.37	162.67
G178.0	164.02	163.47	162.99	162.65	162.51	162.52	162.63	162.80	163.00	163.20	163.40	163.58	163.72
G179.0	165.38	165.04	164.70	164.35	164.00	163.73	163.66	163.83	164.14	164.43	164.59	164.64	164.66
G180.0	165.44	165.44	165.44	165.44	165.44	165.44	165.44	165.44	165.44	165.44	165.44	165.44	165.44

LEDS C4⁺

Luminaire

Code PX-0525-ANT
Name KAPA

Measurement

Code PX-0525-ANT
Name KAPA

Luminaire Flux	443.60 lm	Luminaire Power	10.30 W	Efficacy	43.07 lm/W	Efficiency	100.00%
Sources Flux	443.60 lm	Maximum value	183.99 cd/klm	Position	C=175.00 G=159.00	CG	Asymmetrical

Luminous Intensity Table cd/klm Table 14/18

	C 65.00	C 70.00	C 75.00	C 80.00	C 85.00	C 90.00	C 95.00	C 100.00	C 105.00	C 110.00	C 115.00	C 120.00	C 125.00
G146.0	114.47	117.92	121.42	124.85	128.35	132.16	136.40	140.75	144.81	148.29	151.38	154.40	157.59
G147.0	116.60	120.05	123.50	126.82	130.19	133.89	138.09	142.45	146.51	149.94	152.96	155.91	159.03
G148.0	118.78	122.05	125.41	128.79	132.27	136.00	140.05	144.16	147.98	151.29	154.25	157.16	160.23
G149.0	120.78	124.01	127.32	130.62	134.01	137.65	141.62	145.66	149.43	152.68	155.60	158.46	161.47
G150.0	122.91	125.99	129.18	132.42	135.77	139.36	143.24	147.16	150.81	153.97	156.83	159.66	162.65
G151.0	124.87	127.99	131.18	134.37	137.63	141.10	144.86	148.67	152.23	155.32	158.09	160.82	163.67
G152.0	126.86	129.84	132.88	135.88	138.95	142.31	146.04	149.89	153.49	156.57	159.31	161.97	164.74
G153.0	128.79	131.66	134.61	137.55	140.61	143.94	147.61	151.36	154.84	157.82	160.46	163.04	165.76
G154.0	130.94	133.79	136.64	139.41	142.25	145.37	148.89	152.54	155.96	158.89	161.48	163.96	166.54
G155.0	132.52	135.29	138.17	141.02	143.94	147.07	150.49	153.96	157.21	160.02	162.53	164.98	167.53
G156.0	134.44	137.05	139.78	142.56	145.46	148.55	151.85	155.19	158.29	160.98	163.40	165.74	168.16
G157.0	136.43	138.97	141.62	144.31	147.11	150.09	153.27	156.47	159.44	162.00	164.30	166.55	168.90
G158.0	138.07	140.49	143.03	145.61	148.30	151.20	154.35	157.52	160.46	162.96	165.16	167.29	169.51
G159.0	139.78	142.24	144.72	147.08	149.50	152.21	155.33	158.57	161.55	163.98	166.04	168.01	170.11
G160.0	141.69	143.93	146.16	148.32	150.59	153.19	156.25	159.45	162.35	164.65	166.55	168.40	170.44
G161.0	143.19	145.36	147.53	149.61	151.77	154.25	157.17	160.25	163.08	165.35	167.24	169.04	170.96
G162.0	144.71	146.85	148.98	151.01	153.08	155.44	158.22	161.12	163.77	165.89	167.66	169.36	171.22
G163.0	146.41	148.29	150.19	152.09	154.10	156.44	159.19	162.05	164.60	166.56	168.15	169.70	171.45
G164.0	147.71	149.53	151.42	153.34	155.37	157.63	160.17	162.76	165.09	166.95	168.51	170.04	171.74
G165.0	149.40	151.17	152.96	154.70	156.54	158.67	161.18	163.77	166.04	167.71	169.01	170.27	171.76
G166.0	150.90	152.46	154.08	155.74	157.52	159.54	161.82	164.13	166.17	167.74	169.02	170.31	171.81
G167.0	152.22	153.73	155.27	156.83	158.48	160.35	162.48	164.66	166.58	168.07	169.28	170.49	171.88
G168.0	153.59	154.92	156.28	157.66	159.15	160.92	163.02	165.19	167.11	168.54	169.64	170.69	171.88
G169.0	154.86	156.04	157.28	158.58	160.04	161.72	163.66	165.63	167.33	168.58	169.56	170.53	171.70
G170.0	156.13	157.30	158.45	159.56	160.75	162.21	164.01	165.91	167.59	168.81	169.71	170.55	171.51
G171.0	157.44	158.37	159.27	160.18	161.23	162.61	164.42	166.34	167.95	168.99	169.67	170.33	171.24
G172.0	158.46	159.28	160.06	160.82	161.74	163.03	164.77	166.63	168.16	169.06	169.57	170.09	170.92
G173.0	159.41	160.26	161.04	161.73	162.49	163.54	165.00	166.59	167.94	168.78	169.32	169.85	170.62
G174.0	160.52	161.15	161.73	162.24	162.87	163.85	165.29	166.88	168.15	168.81	169.12	169.44	170.07
G175.0	161.42	161.92	162.39	162.87	163.48	164.38	165.62	166.95	167.99	168.51	168.74	169.02	169.59
G176.0	162.19	162.61	163.01	163.40	163.90	164.67	165.77	166.95	167.87	168.29	168.43	168.58	168.99
G177.0	163.00	163.34	163.66	163.96	164.37	165.03	166.03	167.10	167.89	167.97	168.05	168.14	168.39
G178.0	163.83	163.93	164.09	164.33	164.71	165.29	166.05	166.83	167.38	167.42	167.46	167.50	167.68
G179.0	164.70	164.77	164.86	164.98	165.19	165.54	166.05	166.60	166.98	166.97	166.96	166.96	167.02
G180.0	165.44	165.44	165.44	165.44	165.44	165.44	165.44	165.44	165.44	165.44	165.44	165.44	165.44

LEDS C4⁺

Luminaire

Code PX-0525-ANT
Name KAPA

Measurement

Code PX-0525-ANT
Name KAPA

Luminaire Flux	443.60 lm	Luminaire Power	10.30 W	Efficacy	43.07 lm/W	Efficiency	100.00%
Sources Flux	443.60 lm	Maximum value	183.99 cd/klm	Position	C=175.00 G=159.00	CG	Asymmetrical

Luminous Intensity Table cd/klm Table 15/18

	C 130.00	C 135.00	C 140.00	C 145.00	C 150.00	C 155.00	C 160.00	C 165.00	C 170.00	C 175.00	C 180.00	C 185.00	C 190.00
G146.0	160.82	163.91	166.69	169.19	171.46	173.52	175.26	176.54	177.26	177.52	177.46	177.19	176.69
G147.0	162.21	165.20	167.84	170.19	172.36	174.43	176.23	177.54	178.20	178.39	178.34	178.20	177.86
G148.0	163.33	166.29	168.96	171.35	173.54	175.55	177.26	178.51	179.19	179.40	179.28	178.95	178.40
G149.0	164.51	167.40	169.98	172.30	174.44	176.41	178.09	179.30	179.92	180.08	179.96	179.72	179.29
G150.0	165.67	168.50	170.96	173.14	175.18	177.14	178.88	180.18	180.88	181.07	180.91	180.50	179.88
G151.0	166.56	169.30	171.77	174.00	176.04	177.93	179.54	180.72	181.34	181.53	181.44	181.18	180.72
G152.0	167.54	170.23	172.68	174.90	176.93	178.76	180.30	181.40	181.96	182.10	181.95	181.65	181.16
G153.0	168.52	171.10	173.38	175.40	177.27	179.05	180.60	181.77	182.41	182.62	182.52	182.22	181.70
G154.0	169.14	171.64	173.95	176.07	178.00	179.77	181.25	182.32	182.88	183.03	182.90	182.59	182.09
G155.0	170.10	172.55	174.78	176.78	178.57	180.17	181.52	182.52	183.13	183.37	183.30	182.97	182.39
G156.0	170.60	172.93	175.07	177.02	178.83	180.50	181.92	182.92	183.40	183.48	183.29	182.96	182.47
G157.0	171.27	173.54	175.62	177.50	179.22	180.80	182.12	183.05	183.52	183.61	183.47	183.22	182.79
G158.0	171.77	173.94	175.95	177.78	179.44	180.93	182.18	183.10	183.64	183.82	183.69	183.32	182.73
G159.0	172.25	174.29	176.12	177.77	179.35	180.89	182.27	183.30	183.85	183.99	183.80	183.37	182.76
G160.0	172.59	174.65	176.49	178.13	179.62	181.00	182.19	183.08	183.59	183.74	183.61	183.25	182.68
G161.0	172.95	174.87	176.65	178.26	179.74	181.09	182.23	183.06	183.53	183.65	183.48	183.09	182.50
G162.0	173.15	175.01	176.67	178.16	179.53	180.80	181.89	182.70	183.14	183.25	183.11	182.78	182.28
G163.0	173.33	175.16	176.81	178.29	179.62	180.82	181.83	182.56	182.97	183.09	182.95	182.61	182.08
G164.0	173.52	175.26	176.82	178.20	179.43	180.51	181.42	182.10	182.52	182.68	182.59	182.27	181.75
G165.0	173.42	175.07	176.60	177.97	179.19	180.26	181.14	181.81	182.23	182.38	182.27	181.89	181.29
G166.0	173.45	175.06	176.51	177.78	178.88	179.80	180.54	181.11	181.49	181.67	181.60	181.28	180.75
G167.0	173.39	174.88	176.24	177.44	178.49	179.37	180.09	180.61	180.93	181.04	180.94	180.65	180.18
G168.0	173.20	174.53	175.80	176.95	177.95	178.76	179.41	179.89	180.21	180.34	180.23	179.86	179.30
G169.0	173.01	174.29	175.44	176.44	177.33	178.11	178.75	179.21	179.46	179.50	179.37	179.07	178.63
G170.0	172.56	173.63	174.65	175.60	176.49	177.31	178.00	178.53	178.84	178.93	178.80	178.46	177.96
G171.0	172.31	173.39	174.35	175.18	175.92	176.58	177.15	177.58	177.84	177.89	177.71	177.28	176.71
G172.0	171.96	172.99	173.87	174.58	175.18	175.69	176.13	176.52	176.84	177.01	176.94	176.58	176.02
G173.0	171.53	172.43	173.18	173.81	174.37	174.88	175.34	175.70	175.94	176.00	175.86	175.49	174.99
G174.0	170.91	171.72	172.36	172.87	173.32	173.78	174.23	174.60	174.84	174.91	174.74	174.32	173.76
G175.0	170.34	171.05	171.57	171.95	172.29	172.68	173.09	173.44	173.68	173.77	173.67	173.36	172.91
G176.0	169.57	170.17	170.65	171.03	171.35	171.65	171.94	172.22	172.48	172.62	172.54	172.17	171.63
G177.0	168.83	169.31	169.73	170.07	170.36	170.60	170.82	171.02	171.20	171.27	171.18	170.86	170.41
G178.0	168.02	168.40	168.75	169.03	169.24	169.38	169.49	169.60	169.73	169.81	169.74	169.46	169.03
G179.0	167.18	167.38	167.55	167.72	167.91	168.13	168.37	168.57	168.71	168.71	168.53	168.14	167.64
G180.0	165.44	165.44	165.44	165.44	165.44	165.44	165.44	165.44	165.44	165.44	165.44	165.44	165.44

LEDS C4⁺

Luminaire

Code PX-0525-ANT
Name KAPA

Measurement

Code PX-0525-ANT
Name KAPA

Luminaire Flux	443.60 lm	Luminaire Power	10.30 W	Efficacy	43.07 lm/W	Efficiency	100.00%
Sources Flux	443.60 lm	Maximum value	183.99 cd/klm	Position	C=175.00 G=159.00	CG	Asymmetrical

Luminous Intensity Table cd/klm Table 16/18

	C 195.00	C 200.00	C 205.00	C 210.00	C 215.00	C 220.00	C 225.00	C 230.00	C 235.00	C 240.00	C 245.00	C 250.00	C 255.00
G146.0	175.92	174.83	173.38	171.50	169.18	166.52	163.66	160.67	157.55	154.24	150.70	147.01	143.29
G147.0	177.15	175.93	174.24	172.18	169.83	167.27	164.59	161.83	158.91	155.71	152.18	148.47	144.77
G148.0	177.57	176.43	174.97	173.19	171.10	168.75	166.16	163.38	160.37	157.09	153.53	149.83	146.18
G149.0	178.58	177.49	176.02	174.16	171.95	169.46	166.81	164.05	161.16	158.05	154.69	151.19	147.73
G150.0	179.03	177.95	176.57	174.83	172.69	170.28	167.74	165.19	162.50	159.51	156.12	152.52	149.02
G151.0	179.97	178.86	177.40	175.62	173.55	171.24	168.77	166.18	163.43	160.47	157.28	153.95	150.62
G152.0	180.42	179.38	178.01	176.28	174.22	171.90	169.46	166.98	164.40	161.60	158.52	155.28	152.01
G153.0	180.95	179.92	178.58	176.92	174.93	172.69	170.33	167.91	165.37	162.63	159.63	156.49	153.38
G154.0	181.34	180.31	178.99	177.40	175.56	173.50	171.26	168.86	166.29	163.53	160.56	157.50	154.48
G155.0	181.61	180.62	179.38	177.84	175.96	173.85	171.64	169.41	167.07	164.51	161.64	158.61	155.60
G156.0	181.76	180.78	179.55	178.09	176.39	174.51	172.45	170.25	167.87	165.27	162.46	159.52	156.59
G157.0	182.10	181.10	179.81	178.29	176.58	174.71	172.68	170.50	168.18	165.72	163.13	160.48	157.81
G158.0	181.95	181.00	179.85	178.48	176.86	175.05	173.10	171.05	168.88	166.55	164.05	161.42	158.76
G159.0	181.98	181.07	179.99	178.69	177.13	175.37	173.47	171.49	169.39	167.15	164.73	162.22	159.69
G160.0	181.93	181.03	179.97	178.74	177.34	175.77	174.03	172.11	170.03	167.79	165.42	162.97	160.54
G161.0	181.76	180.88	179.86	178.65	177.23	175.64	173.95	172.18	170.29	168.22	165.92	163.50	161.12
G162.0	181.64	180.87	179.91	178.71	177.23	175.59	173.90	172.26	170.57	168.71	166.60	164.32	162.02
G163.0	181.38	180.52	179.52	178.41	177.20	175.86	174.35	172.67	170.83	168.89	166.88	164.82	162.75
G164.0	181.07	180.26	179.31	178.22	176.98	175.63	174.19	172.68	171.10	169.39	167.54	165.57	163.51
G165.0	180.55	179.72	178.81	177.80	176.68	175.46	174.14	172.73	171.23	169.62	167.90	166.07	164.14
G166.0	180.05	179.22	178.32	177.36	176.36	175.29	174.11	172.79	171.34	169.78	168.12	166.38	164.60
G167.0	179.58	178.89	178.09	177.15	176.07	174.89	173.69	172.51	171.29	169.95	168.42	166.76	165.06
G168.0	178.67	178.04	177.37	176.60	175.69	174.68	173.62	172.54	171.38	170.06	168.51	166.84	165.22
G169.0	178.10	177.47	176.78	176.01	175.17	174.25	173.23	172.11	170.92	169.69	168.47	167.21	165.89
G170.0	177.38	176.75	176.07	175.31	174.44	173.54	172.69	171.92	171.12	170.12	168.82	167.34	165.86
G171.0	176.12	175.60	175.10	174.54	173.86	173.09	172.28	171.47	170.61	169.63	168.48	167.24	166.01
G172.0	175.40	174.84	174.32	173.81	173.26	172.64	171.91	171.05	170.10	169.15	168.23	167.34	166.40
G173.0	174.48	174.05	173.64	173.14	172.49	171.77	171.06	170.46	169.86	169.16	168.28	167.28	166.26
G174.0	173.21	172.77	172.41	172.06	171.66	171.19	170.66	170.05	169.37	168.63	167.84	167.03	166.22
G175.0	172.43	171.97	171.56	171.15	170.73	170.29	169.82	169.32	168.80	168.27	167.76	167.21	166.57
G176.0	171.09	170.66	170.33	170.03	169.72	169.41	169.11	168.84	168.54	168.11	167.51	166.82	166.14
G177.0	169.95	169.58	169.29	169.02	168.74	168.45	168.15	167.87	167.58	167.29	166.98	166.63	166.23
G178.0	168.57	168.15	167.81	167.56	167.41	167.32	167.23	167.11	166.93	166.69	166.39	166.09	165.84
G179.0	167.17	166.84	166.64	166.52	166.48	166.43	166.39	166.38	166.36	166.35	166.08	165.73	165.43
G180.0	165.44	165.44	165.44	165.44	165.44	165.44	165.44	165.44	165.44	165.44	165.44	165.44	165.44

LEDS C4⁺

Luminaire

Code PX-0525-ANT
Name KAPA

Measurerm.

Code PX-0525-ANT
Name KAPA

Luminaire Flux	443.60 lm	Luminaire Power	10.30 W	Efficacy	43.07 lm/W	Efficiency	100.00%
Sources Flux	443.60 lm	Maximum value	183.99 cd/klm	Position	C=175.00 G=159.00	CG	Asymmetrical

Luminous Intensity Table cd/klm Table 17/18

	C 260.00	C 265.00	C 270.00	C 275.00	C 280.00	C 285.00	C 290.00	C 295.00	C 300.00	C 305.00	C 310.00	C 315.00	C 320.00
G146.0	139.61	135.97	132.33	128.69	125.13	121.79	118.73	115.84	112.99	110.08	107.25	104.71	102.60
G147.0	141.23	137.79	134.32	130.76	127.21	123.83	120.73	117.82	114.97	112.12	109.37	106.91	104.85
G148.0	142.70	139.34	136.00	132.61	129.25	126.02	122.99	120.11	117.30	114.51	111.83	109.40	107.34
G149.0	144.39	141.13	137.83	134.43	131.04	127.82	124.86	122.08	119.35	116.59	113.93	111.55	109.59
G150.0	145.80	142.74	139.63	136.33	132.97	129.75	126.81	124.08	121.42	118.74	116.15	113.83	111.87
G151.0	147.38	144.21	141.05	137.87	134.72	131.69	128.85	126.14	123.50	120.88	118.38	116.12	114.18
G152.0	148.82	145.72	142.65	139.57	136.54	133.60	130.81	128.13	125.52	122.97	120.56	118.40	116.57
G153.0	150.40	147.47	144.49	141.35	138.21	135.22	132.50	129.98	127.52	125.01	122.60	120.44	118.66
G154.0	151.59	148.76	145.87	142.85	139.81	136.94	134.34	131.92	129.55	127.11	124.74	122.63	120.88
G155.0	152.74	149.98	147.18	144.28	141.38	138.63	136.12	133.78	131.46	129.09	126.79	124.75	123.08
G156.0	153.77	151.03	148.34	145.67	143.03	140.45	137.96	135.55	133.19	130.90	128.74	126.83	125.23
G157.0	155.17	152.54	149.89	147.21	144.56	142.02	139.63	137.36	135.15	132.96	130.86	128.97	127.34
G158.0	156.12	153.52	150.98	148.49	146.08	143.73	141.45	139.23	137.04	134.88	132.84	131.04	129.54
G159.0	157.23	154.80	152.37	149.92	147.48	145.14	142.95	140.85	138.78	136.71	134.74	133.01	131.61
G160.0	158.16	155.83	153.51	151.20	148.91	146.71	144.63	142.62	140.65	138.69	136.82	135.13	133.70
G161.0	158.87	156.73	154.62	152.50	150.37	148.28	146.23	144.24	142.32	140.48	138.76	137.23	135.91
G162.0	159.80	157.66	155.58	153.54	151.54	149.59	147.68	145.80	143.95	142.14	140.44	138.97	137.78
G163.0	160.68	158.63	156.64	154.72	152.85	151.02	149.21	147.41	145.64	143.91	142.28	140.82	139.59
G164.0	161.40	159.33	157.40	155.65	154.03	152.42	150.74	149.01	147.28	145.60	144.04	142.69	141.61
G165.0	162.15	160.18	158.34	156.68	155.14	153.61	152.01	150.37	148.73	147.14	145.68	144.40	143.36
G166.0	162.79	161.01	159.32	157.76	156.28	154.80	153.27	151.72	150.20	148.77	147.45	146.30	145.34
G167.0	163.40	161.80	160.26	158.80	157.39	155.99	154.59	153.19	151.78	150.40	149.10	147.97	147.06
G168.0	163.75	162.40	161.11	159.83	158.53	157.22	155.88	154.52	153.16	151.81	150.57	149.52	148.72
G169.0	164.49	163.07	161.73	160.53	159.40	158.27	157.05	155.80	154.56	153.41	152.34	151.37	150.50
G170.0	164.51	163.31	162.26	161.31	160.39	159.40	158.28	157.10	155.95	154.90	153.96	153.10	152.30
G171.0	164.86	163.82	162.88	162.04	161.23	160.34	159.32	158.22	157.11	156.09	155.18	154.46	153.93
G172.0	165.41	164.41	163.48	162.67	161.93	161.16	160.30	159.38	158.44	157.53	156.71	156.02	155.51
G173.0	165.32	164.50	163.82	163.29	162.79	162.17	161.32	160.36	159.42	158.64	158.01	157.54	157.18
G174.0	165.43	164.73	164.17	163.76	163.40	162.94	162.27	161.46	160.65	159.92	159.32	158.86	158.55
G175.0	165.82	165.09	164.53	164.25	164.07	163.76	163.17	162.40	161.64	161.05	160.61	160.26	159.97
G176.0	165.57	165.14	164.88	164.78	164.71	164.48	163.98	163.32	162.70	162.25	161.96	161.76	161.60
G177.0	165.77	165.36	165.13	165.14	165.23	165.14	164.72	164.11	163.51	163.09	162.86	162.77	162.77
G178.0	165.78	165.72	165.66	165.59	165.51	165.44	165.15	164.81	164.49	164.29	164.17	164.10	164.05
G179.0	165.29	165.32	165.51	165.83	166.12	166.20	165.97	165.58	165.26	165.17	165.25	165.38	165.46
G180.0	165.44	165.44	165.44	165.44	165.44	165.44	165.44	165.44	165.44	165.44	165.44	165.44	165.44

LEDS C4⁺

Luminaire

Code PX-0525-ANT
Name KAPA

Measurem.

Code PX-0525-ANT
Name KAPA

Luminaire Flux	443.60 lm	Luminaire Power	10.30 W	Efficacy	43.07 lm/W	Efficiency	100.00%
Sources Flux	443.60 lm	Maximum value	183.99 cd/klm	Position	C=175.00 G=159.00	CG	Asymmetrical

Luminous Intensity Table cd/klm Table 18/18

	C 325.00	C 330.00	C 335.00	C 340.00	C 345.00	C 350.00	C 355.00
G146.0	100.82	99.20	97.63	96.22	95.14	94.51	94.23
G147.0	103.10	101.53	100.05	98.73	97.74	97.15	96.87
G148.0	105.56	103.97	102.49	101.22	100.26	99.68	99.39
G149.0	107.94	106.43	104.95	103.63	102.63	102.07	101.84
G150.0	110.21	108.73	107.35	106.14	105.24	104.71	104.47
G151.0	112.51	111.04	109.71	108.57	107.72	107.21	106.94
G152.0	114.98	113.52	112.11	110.85	109.91	109.39	109.19
G153.0	117.19	115.87	114.62	113.52	112.66	112.14	111.87
G154.0	119.42	118.11	116.86	115.74	114.90	114.43	114.22
G155.0	121.69	120.43	119.20	118.10	117.25	116.76	116.53
G156.0	123.87	122.63	121.44	120.39	119.59	119.12	118.91
G157.0	125.95	124.72	123.62	122.69	121.99	121.56	121.34
G158.0	128.27	127.10	125.96	124.93	124.14	123.70	123.52
G159.0	130.44	129.36	128.27	127.27	126.50	126.06	125.87
G160.0	132.47	131.38	130.35	129.47	128.80	128.41	128.23
G161.0	134.75	133.64	132.55	131.57	130.84	130.68	130.52
G162.0	136.79	135.85	134.86	133.94	133.23	132.84	132.68
G163.0	138.53	137.61	136.76	136.03	135.48	135.14	134.96
G164.0	140.71	139.86	138.98	138.16	137.52	137.16	137.00
G165.0	142.49	141.72	141.01	140.37	139.87	139.55	139.35
G166.0	144.51	143.75	143.01	142.36	141.85	141.54	141.37
G167.0	146.30	145.61	144.92	144.29	143.81	143.53	143.39
G168.0	148.10	147.54	146.94	146.39	145.95	145.84	145.73
G169.0	149.74	149.13	148.66	148.32	148.06	147.86	147.70
G170.0	151.58	150.96	150.47	150.10	149.84	149.69	149.61
G171.0	153.52	153.12	152.66	152.21	151.84	151.63	151.54
G172.0	155.11	154.74	154.34	153.97	153.69	153.62	153.56
G173.0	156.87	156.53	156.12	155.70	155.38	155.35	155.31
G174.0	158.32	158.09	157.79	157.48	157.23	157.18	157.14
G175.0	159.71	159.51	159.36	159.25	159.17	159.10	159.04
G176.0	161.43	161.23	160.99	160.75	160.58	160.57	160.57
G177.0	162.80	162.80	162.73	162.61	162.49	162.41	162.37
G178.0	164.01	163.97	163.93	163.90	163.90	163.92	163.97
G179.0	165.48	165.49	165.49	165.48	165.47	165.45	165.42
G180.0	165.44	165.44	165.44	165.44	165.44	165.44	165.44

LEDS C4²

Luminaire

Code PX-0525-ANT
Name KAPA

Measurem.

Code PX-0525-ANT
Name KAPA

Luminaire Flux	443.60 lm	Luminaire Power	10.30 W	Efficacy	43.07 lm/W	Efficiency	100.00%
Sources Flux	443.60 lm	Maximum value	183.99 cd/klm	Position	C=175.00 G=159.00	CG	Asymmetrical

220mm x 100mm

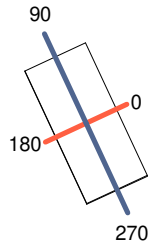

C Halfplanes

180.0 ———— 0.0
270.0 ———— 90.0

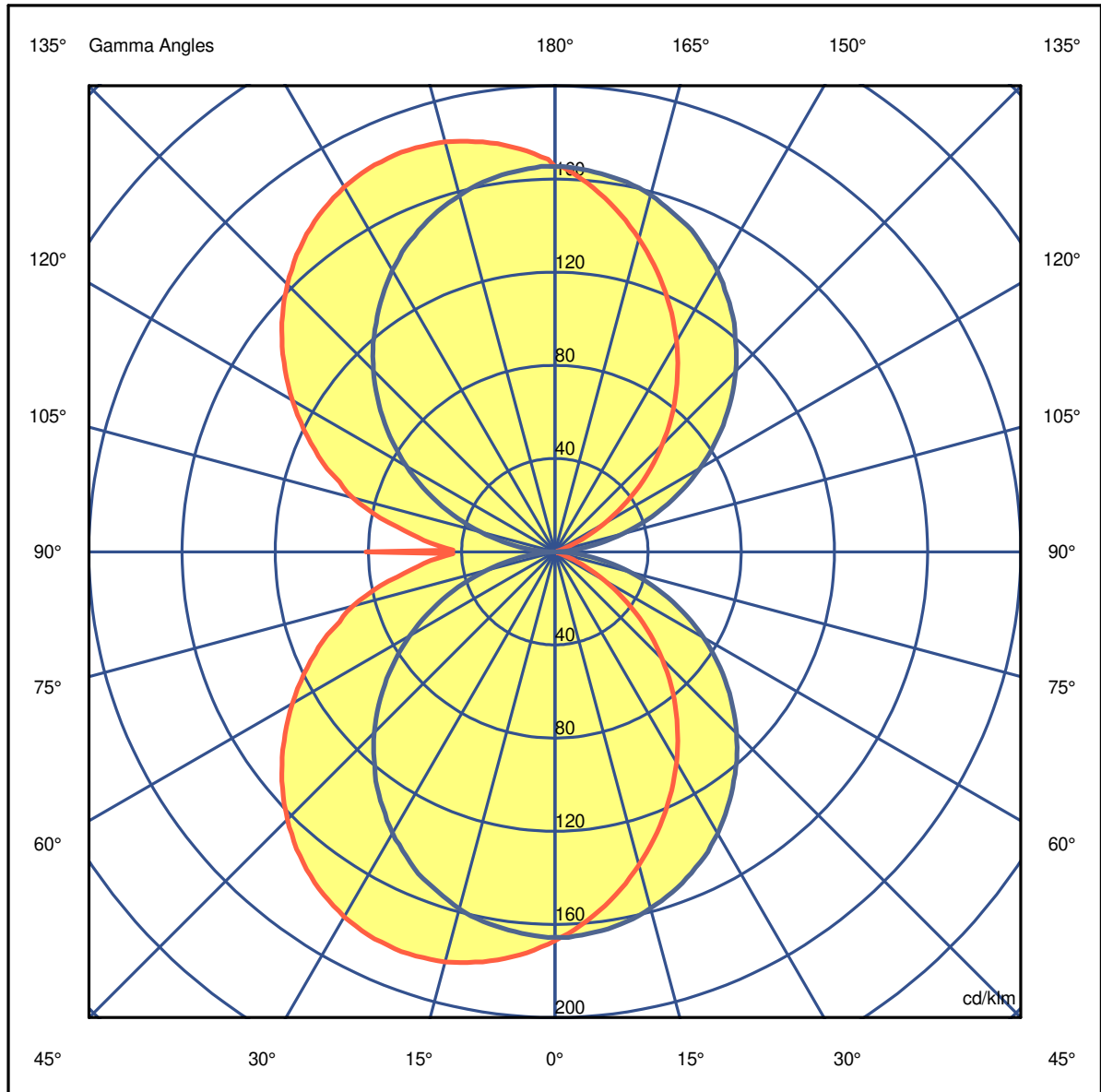

LEDS C4²

Luminaire

Code PX-0525-ANT
Name KAPA

Measurem.

Code PX-0525-ANT
Name KAPA

Luminaire Flux	443.60 lm	Luminaire Power	10.30 W	Efficacy	43.07 lm/W	Efficiency	100.00%
Sources Flux	443.60 lm	Maximum value	183.99 cd/klm	Position	C=175.00 G=159.00	CG	Asymmetrical

220mm x 100mm

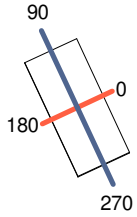

C Halfplanes
180.0 ——— 0.0
270.0 ——— 90.0

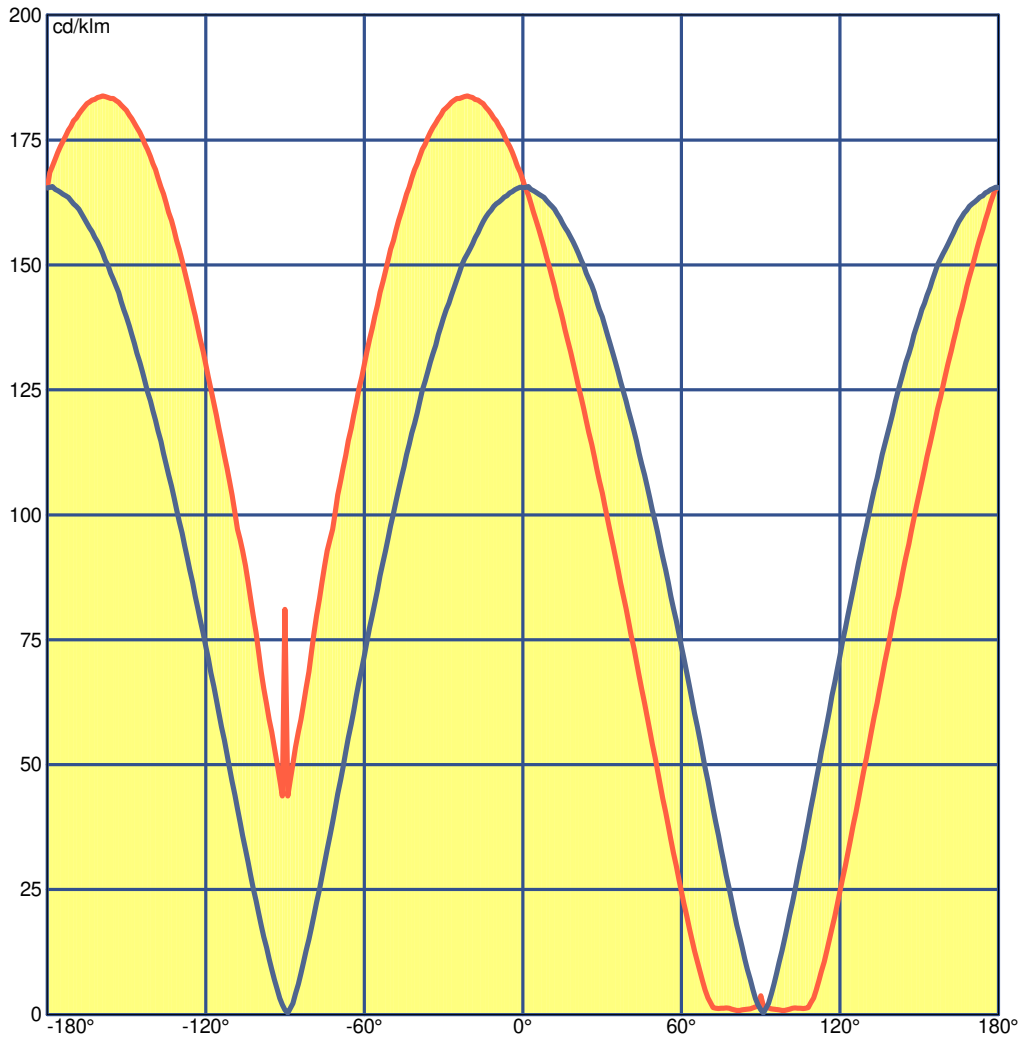

LEDS C4²

Luminaire

Code PX-0525-ANT
Name KAPA

Measurem.

Code PX-0525-ANT
Name KAPA

Luminaire Flux	443.60 lm	Luminaire Power	10.30 W	Efficacy	43.07 lm/W	Efficiency	100.00%
Sources Flux	443.60 lm	Maximum value	183.99 cd/klm	Position	C=175.00 G=159.00	CG	Asymmetrical

UGR
S = 0.250

Reflectancies										
Ceiling/Cavity	0.7	0.7	0.5	0.5	0.3	0.7	0.7	0.5	0.5	0.3
Walls	0.5	0.3	0.5	0.3	0.3	0.5	0.3	0.5	0.3	0.3
WorkingPlane	0.2	0.2	0.2	0.2	0.2	0.2	0.2	0.2	0.2	0.2
RoomDimensions	Viewed Crosswise					Viewed Endwise				
x=2H y=2H	13.8	14.6	14.7	15.5	16.6	10.5	11.3	11.4	12.2	13.3
x=2H y=3H	16.2	16.9	17.1	17.9	19.0	12.0	12.7	12.9	13.6	14.8
x=2H y=4H	17.4	18.1	18.4	19.1	20.2	12.6	13.2	13.5	14.2	15.4
x=2H y=6H	18.7	19.3	19.6	20.2	21.4	12.9	13.6	13.9	14.5	15.7
x=2H y=8H	19.3	19.9	20.2	20.8	22.1	13.0	13.6	14.0	14.6	15.8
x=2H y=12H	20.0	20.5	20.9	21.5	22.7	13.1	13.6	14.0	14.6	15.8
x=4H y=2H	14.4	15.1	15.3	16.0	17.2	11.4	12.1	12.3	13.0	14.2
x=4H y=3H	17.0	17.6	18.0	18.6	19.8	13.1	13.7	14.0	14.6	15.8
x=4H y=4H	18.4	18.9	19.4	19.9	21.2	13.8	14.3	14.8	15.3	16.5
x=4H y=6H	19.9	20.3	20.9	21.3	22.6	14.3	14.7	15.3	15.7	17.0
x=4H y=8H	20.6	21.0	21.6	22.0	23.3	14.5	14.9	15.5	15.8	17.1
x=4H y=12H	21.4	21.7	22.4	22.7	24.0	14.5	14.9	15.5	15.9	17.2
x=8H y=4H	18.7	19.1	19.7	20.1	21.4	14.5	14.9	15.5	15.9	17.2
x=8H y=6H	20.4	20.8	21.4	21.8	23.1	15.3	15.6	16.3	16.6	17.9
x=8H y=8H	21.3	21.6	22.4	22.6	24.0	15.5	15.8	16.6	16.9	18.2
x=8H y=12H	22.3	22.6	23.4	23.6	25.0	15.7	16.0	16.8	17.0	18.4
x=12H y=4H	18.7	19.1	19.8	20.1	21.4	14.7	15.0	15.7	16.0	17.3
x=12H y=6H	20.5	20.8	21.5	21.8	23.2	15.6	15.9	16.6	16.9	18.2
x=12H y=8H	21.5	21.7	22.5	22.8	24.1	16.0	16.2	17.0	17.3	18.6

LEDS C4⁺

Luminaire

Code PX-0525-ANT
Name KAPA

Measurerm.

Code PX-0525-ANT
Name KAPA

Luminaire Flux	443.60 lm	Luminaire Power	10.30 W	Efficacy	43.07 lm/W	Efficiency	100.00%
Sources Flux	443.60 lm	Maximum value	183.99 cd/klm	Position	C=175.00 G=159.00	CG	Asymmetrical

Total Flux=443.60 Luminaire Flux=443.60

RI	0.60	0.80	1.00	1.25	1.50	2.00	2.50	3.00	4.00	5.00	10.00	20.00
DRR	0.29	0.37	0.44	0.51	0.57	0.65	0.71	0.75	0.80	0.83	0.91	0.95
RC	5	5	5	5	5	6	6	6	6	6	6	6

Zonal Flux per 1000 Lumen

Y°	10	20	30	40	50	60	70	80	90	100	110	120	130	140	150	160	170	180
ZF(Y)	16	61	129	212	298	376	438	478	500	522	562	624	702	788	871	939	984	1000

CIE Flux Codes

45 75 92 50 100

C.I.E. 5/5/5/5/5/6/6/6/6/6/6
D DIN 5040 C31
F UTE 0.50 E + 0.50 T
B NBN BZ 5
RN 49.99999 %
BLF 1.0

LOR 100.00000 %
ULOR 49.99999 %
DLOR 50.00001 %
UFF 49.99999 %
DFF 50.00001 %
FFR 99.99995 %

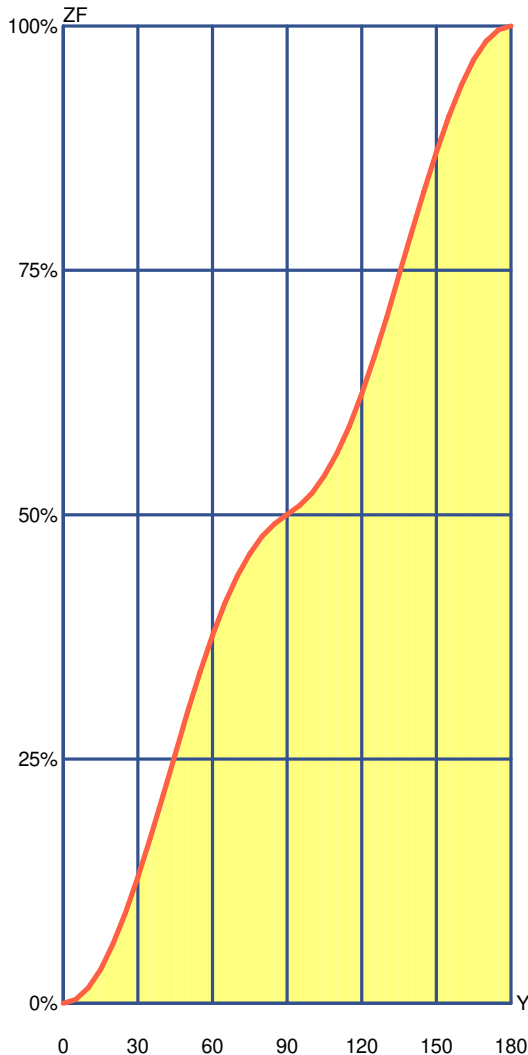

Gamma °	Zonal Flux			
	Flux	Sum lm	Flux [%]	Sum [%]
0°	0.00	0.00	0.00%	0.00%
5°	3.96	3.96	0.40%	0.40%
10°	11.74	15.70	1.17%	1.57%
15°	19.13	34.84	1.91%	3.48%
20°	25.88	60.72	2.59%	6.07%
25°	31.76	92.48	3.18%	9.25%
30°	36.59	129.08	3.66%	12.91%
35°	40.21	169.28	4.02%	16.93%
40°	42.48	211.77	4.25%	21.18%
45°	43.36	255.13	4.34%	25.51%
50°	42.81	297.93	4.28%	29.79%
55°	40.86	338.79	4.09%	33.88%
60°	37.60	376.39	3.76%	37.64%
65°	33.24	409.63	3.32%	40.96%
70°	28.06	437.69	2.81%	43.77%
75°	22.60	460.30	2.26%	46.03%
80°	17.58	477.88	1.76%	47.79%
85°	12.74	490.61	1.27%	49.06%
90°	9.39	500.00	0.94%	50.00%
95°	9.39	509.39	0.94%	50.94%
100°	12.74	522.12	1.27%	52.21%
105°	17.58	539.70	1.76%	53.97%
110°	22.60	562.31	2.26%	56.23%
115°	28.06	590.37	2.81%	59.04%
120°	33.24	623.61	3.32%	62.36%
125°	37.60	661.21	3.76%	66.12%
130°	40.86	702.07	4.09%	70.21%
135°	42.81	744.87	4.28%	74.49%
140°	43.36	788.23	4.34%	78.82%
145°	42.48	830.72	4.25%	83.07%
150°	40.21	870.92	4.02%	87.09%
155°	36.59	907.52	3.66%	90.75%
160°	31.76	939.28	3.18%	93.93%
165°	25.88	965.16	2.59%	96.52%
170°	19.13	984.30	1.91%	98.43%
175°	11.74	996.04	1.17%	99.60%
180°	3.96	1000.00	0.40%	100.00%

LEDS C4⁺

Luminaire

Code PX-0525-ANT
Name KAPA

Measurerm.

Code PX-0525-ANT
Name KAPA

Luminaire Flux	443.60 lm	Luminaire Power	10.30 W	Efficacy	43.07 lm/W	Efficiency	100.00%
Sources Flux	443.60 lm	Maximum value	183.99 cd/klm	Position	C=175.00 G=159.00	CG	Asymmetrical

Utilizations CIE

Mounting	Direct	Normalization										Normalised										Suspension Ratid/3										Standard CIE Settings																																																																																																																																																																																																																																																																																							
Ceiling																																																																																																																																																																																																																																																																																																																							
K	8873	8773	8871	8771	7773	7771	7753	7553	7751	7551	7731	7331	7711	7111	5551	5531	5331	5511	5111	3331	3311	1111	0000	0.60	552	496	517	466	472	445	416	353	399	340	368	278	346	236	318	297	263	282	225	249	237	205	187	0.80	610	560	555	512	532	489	470	411	441	388	407	324	381	279	363	339	306	320	266	290	276	243	222	1.00	650	604	577	540	575	517	511	456	470	422	434	358	407	312	395	370	339	350	298	322	307	273	250	1.25	685	645	592	561	613	539	550	500	494	452	459	390	431	345	424	399	371	378	330	353	337	304	278	1.50	709	674	600	574	642	552	581	534	510	473	477	415	449	371	446	421	395	400	356	377	361	328	300	2.00	742	713	607	587	680	568	624	584	531	501	501	450	475	409	475	452	430	432	393	412	396	366	333	2.50	762	738	610	594	705	575	654	619	544	519	517	473	493	436	494	473	454	454	420	435	421	392	357	3.00	777	756	610	597	722	580	677	645	552	531	528	490	506	456	507	488	471	471	440	453	440	412	375	4.00	796	779	610	600	746	585	707	682	563	546	542	512	524	483	524	508	494	493	468	477	465	441	400	5.00	807	794	610	602	760	588	727	706	569	556	552	527	536	501	535	521	509	508	487	493	482	460	417	10.00	831	824	606	602	791	592	771	759	581	574	571	558	561	542	557	548	542	540	529	528	521	503	455	20.00	844	840	603	601	807	593	796	790	587	583	581	574	576	566	568	563	560	559	552	547	543	528	476

Wall

K	8873	8773	8871	8771	7773	7771	7753	7553	7751	7551	7731	7331	7711	7111	5551	5531	5331	5511	5111	3331	3311	1111	0000	0.60	385	355	340	315	339	301	267	238	243	218	204	169	175	137	204	174	161	151	132	153	134	121	107	0.80	446	416	383	359	393	341	320	289	285	258	244	206	214	171	239	207	193	183	161	181	161	144	126	1.00	490	460	411	388	432	367	361	329	314	288	274	235	243	198	263	232	217	208	185	201	182	161	139	1.25	530	502	434	414	469	390	400	368	341	316	302	264	272	226	286	256	241	233	209	221	202	177	152	1.50	559	534	450	432	496	406	431	400	361	337	324	287	295	250	303	275	261	252	228	236	218	190	162	2.00	597	575	467	452	532	423	473	445	385	364	353	319	325	283	324	299	286	278	255	255	239	206	174	2.50	622	603	477	464	555	434	503	477	401	383	372	341	347	308	338	316	304	297	275	269	254	217	182	3.00	639	622	483	472	572	441	525	500	412	396	386	358	363	326	347	328	316	310	290	278	265	225	187	4.00	666	652	494	486	598	454	558	537	430	416	408	384	388	356	364	348	338	332	315	295	283	239	198	5.00	685	673	503	496	616	464	582	564	443	432	424	404	406	379	377	362	354	349	333	307	297	250	207	10.00	731	725	527	523	661	489	641	630	477	471	466	453	454	437	410	401	396	392	382	341	334	281	232	20.00	761	757	544	542	691	507	679	673	500	497	494	487	487	477	433	427	424	422	416	365	361	303	251
---	------	------	------	------	------	------	------	------	------	------	------	------	------	------	------	------	------	------	------	------	------	------	------	------	-----	-----	-----	-----	-----	-----	-----	-----	-----	-----	-----	-----	-----	-----	-----	-----	-----	-----	-----	-----	-----	-----	-----	------	-----	-----	-----	-----	-----	-----	-----	-----	-----	-----	-----	-----	-----	-----	-----	-----	-----	-----	-----	-----	-----	-----	-----	------	-----	-----	-----	-----	-----	-----	-----	-----	-----	-----	-----	-----	-----	-----	-----	-----	-----	-----	-----	-----	-----	-----	-----	------	-----	-----	-----	-----	-----	-----	-----	-----	-----	-----	-----	-----	-----	-----	-----	-----	-----	-----	-----	-----	-----	-----	-----	------	-----	-----	-----	-----	-----	-----	-----	-----	-----	-----	-----	-----	-----	-----	-----	-----	-----	-----	-----	-----	-----	-----	-----	------	-----	-----	-----	-----	-----	-----	-----	-----	-----	-----	-----	-----	-----	-----	-----	-----	-----	-----	-----	-----	-----	-----	-----	------	-----	-----	-----	-----	-----	-----	-----	-----	-----	-----	-----	-----	-----	-----	-----	-----	-----	-----	-----	-----	-----	-----	-----	------	-----	-----	-----	-----	-----	-----	-----	-----	-----	-----	-----	-----	-----	-----	-----	-----	-----	-----	-----	-----	-----	-----	-----	------	-----	-----	-----	-----	-----	-----	-----	-----	-----	-----	-----	-----	-----	-----	-----	-----	-----	-----	-----	-----	-----	-----	-----	------	-----	-----	-----	-----	-----	-----	-----	-----	-----	-----	-----	-----	-----	-----	-----	-----	-----	-----	-----	-----	-----	-----	-----	-------	-----	-----	-----	-----	-----	-----	-----	-----	-----	-----	-----	-----	-----	-----	-----	-----	-----	-----	-----	-----	-----	-----	-----	-------	-----	-----	-----	-----	-----	-----	-----	-----	-----	-----	-----	-----	-----	-----	-----	-----	-----	-----	-----	-----	-----	-----	-----

Working Pl.

K	8873	8773	8871	8771	7773	7771	7753	7553	7751	7551	7731	7331	7711	7111	5551	5531	5331	5511	5111	3331	3311	1111	0000	0.60	458	426	427	399	405	381	318	289	306	279	256	220	219	182	261	221	209	192	174	198	173	159	145	0.80	558	523	514	485	494	460	404	369	385	354	331	288	291	243	326	285	269	253	229	251	225	204	186	1.00	637	602	581	552	565	522	475	438	449	417	395	348	354	299	380	339	321	306	278	297	270	242	221	1.25	713	679	643	616	634	580	547	508	512	479	460	409	418	358	433	393	374	361	330	342	316	280	256	1.50	771	739	689	664	687	624	603	564	560	528	510	460	469	407	474	436	416	404	372	377	353	310	283	2.00	855	826	753	732	764	686	689	652	632	602	586	538	548	487	536	502	483	473	441	432	410	357	326	2.50	910	885	794	776	815	727	749	714	679	653	639	594	603	545	577	547	529	520	489	470	450	388	355	3.00	950	927	823	807	853	755	792	760	713	689	677	635	644	590	607	580	563	556	526	497	479	411	375	4.00	1000	983	859	847	901	792	851	823	757	738	727	691	699	651	646	623	609	603	577	533	517	441	401	5.00	1000	1000	881	871	932	814	888	864	785	768	759	728	734	692	671	651	639	633	610	556	542	460	417	10.00	1000	1000	928	922	999	861	973	959	845	835	829	811	814	789	725	714	706	702	688	607	599	502	454	20.00	1000	1000	952	949	1000	887	1000	1000	878	873	869	859	861	847	756	749	745	743	735	636	632	527	475
---	------	------	------	------	------	------	------	------	------	------	------	------	------	------	------	------	------	------	------	------	------	------	------	------	-----	-----	-----	-----	-----	-----	-----	-----	-----	-----	-----	-----	-----	-----	-----	-----	-----	-----	-----	-----	-----	-----	-----	------	-----	-----	-----	-----	-----	-----	-----	-----	-----	-----	-----	-----	-----	-----	-----	-----	-----	-----	-----	-----	-----	-----	-----	------	-----	-----	-----	-----	-----	-----	-----	-----	-----	-----	-----	-----	-----	-----	-----	-----	-----	-----	-----	-----	-----	-----	-----	------	-----	-----	-----	-----	-----	-----	-----	-----	-----	-----	-----	-----	-----	-----	-----	-----	-----	-----	-----	-----	-----	-----	-----	------	-----	-----	-----	-----	-----	-----	-----	-----	-----	-----	-----	-----	-----	-----	-----	-----	-----	-----	-----	-----	-----	-----	-----	------	-----	-----	-----	-----	-----	-----	-----	-----	-----	-----	-----	-----	-----	-----	-----	-----	-----	-----	-----	-----	-----	-----	-----	------	-----	-----	-----	-----	-----	-----	-----	-----	-----	-----	-----	-----	-----	-----	-----	-----	-----	-----	-----	-----	-----	-----	-----	------	-----	-----	-----	-----	-----	-----	-----	-----	-----	-----	-----	-----	-----	-----	-----	-----	-----	-----	-----	-----	-----	-----	-----	------	------	-----	-----	-----	-----	-----	-----	-----	-----	-----	-----	-----	-----	-----	-----	-----	-----	-----	-----	-----	-----	-----	-----	------	------	------	-----	-----	-----	-----	-----	-----	-----	-----	-----	-----	-----	-----	-----	-----	-----	-----	-----	-----	-----	-----	-----	-------	------	------	-----	-----	-----	-----	-----	-----	-----	-----	-----	-----	-----	-----	-----	-----	-----	-----	-----	-----	-----	-----	-----	-------	------	------	-----	-----	------	-----	------	------	-----	-----	-----	-----	-----	-----	-----	-----	-----	-----	-----	-----	-----	-----	-----

LM53 SHR C0-C180: 0.965 SHR C90-C270: 1.238 SHR Square: 1.176

LEDS C4[®]

Luminaire

Code PX-0525-ANT
Name KAPA

Measurem.

Code PX-0525-ANT
Name KAPA

Luminaire Flux	443.60 lm	Luminaire Power	10.30 W	Efficacy	43.07 lm/W	Efficiency	100.00%
Sources Flux	443.60 lm	Maximum value	183.99 cd/klm	Position	C=175.00 G=159.00	CG	Asymmetrical

Width at 50.00 % of Max Intensity

H[m]	1.00	2.00	3.00	4.00	5.00	H[m]	1.00	2.00	3.00	4.00	5.00
OA	1.08	2.16	3.24	4.32	5.40	OC	1.53	3.05	4.58	6.10	7.63
OB	3.17	6.34	9.52	12.69	15.86	OD	1.53	3.05	4.58	6.11	7.63

	Luminous Intensities [cd/klm]									
	0	5	15	25	35	45	55	65	75	85
OA	74.05	70.52	61.76	51.65	40.63	28.90	16.77	5.64	0.56	0.48
OB	74.05	77.04	80.85	81.31	78.29	72.04	62.96	52.01	39.82	25.08
OC	73.39	72.99	70.24	65.29	57.89	48.87	38.36	26.74	14.67	3.99
OD	73.39	72.92	70.38	65.24	57.89	48.63	37.68	25.76	13.46	2.70

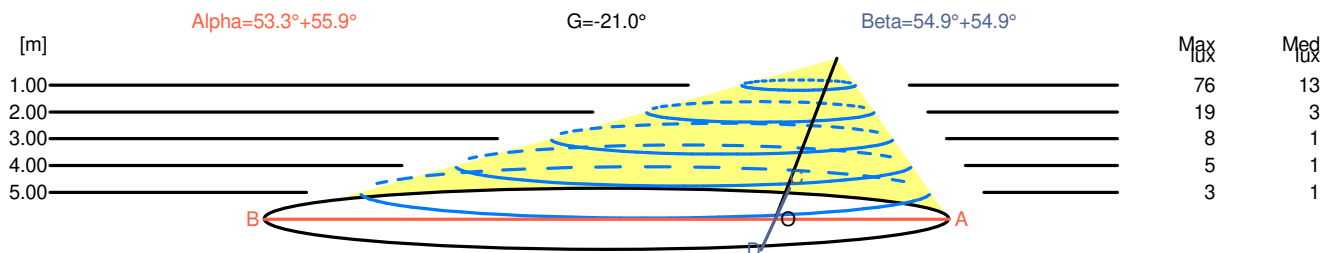

H[m]	D[m]	Max lux	Med lux	Alpha=53.3°+55.9°	G=-21.0	
1.00	4.25	76	13			
2.00	8.51	19	3			
3.00	12.76	8	1			
4.00	17.01	5	1			
5.00	21.26	3	1			

H[m]	D[m]	Max lux	Med lux	Beta=54.9°+54.9°	G=0.0	
1.00	3.05	76	13			
2.00	6.10	19	3			
3.00	9.16	8	1			
4.00	12.21	5	1			
5.00	15.26	3	1			

LEDS C4²

Luminaire

Code PX-0525-ANT
Name KAPA

Measur.

Code PX-0525-ANT
Name KAPA

Luminaire Flux	443.60 lm	Luminaire Power	10.30 W	Efficacy	43.07 lm/W	Efficiency	100.00%
Sources Flux	443.60 lm	Maximum value	183.99 cd/klm	Position	C=175.00 G=159.00	CG	Asymmetrical

Isolux (Floor)

Luminaire position X=0.00m Y=0.00m Z=2.50m

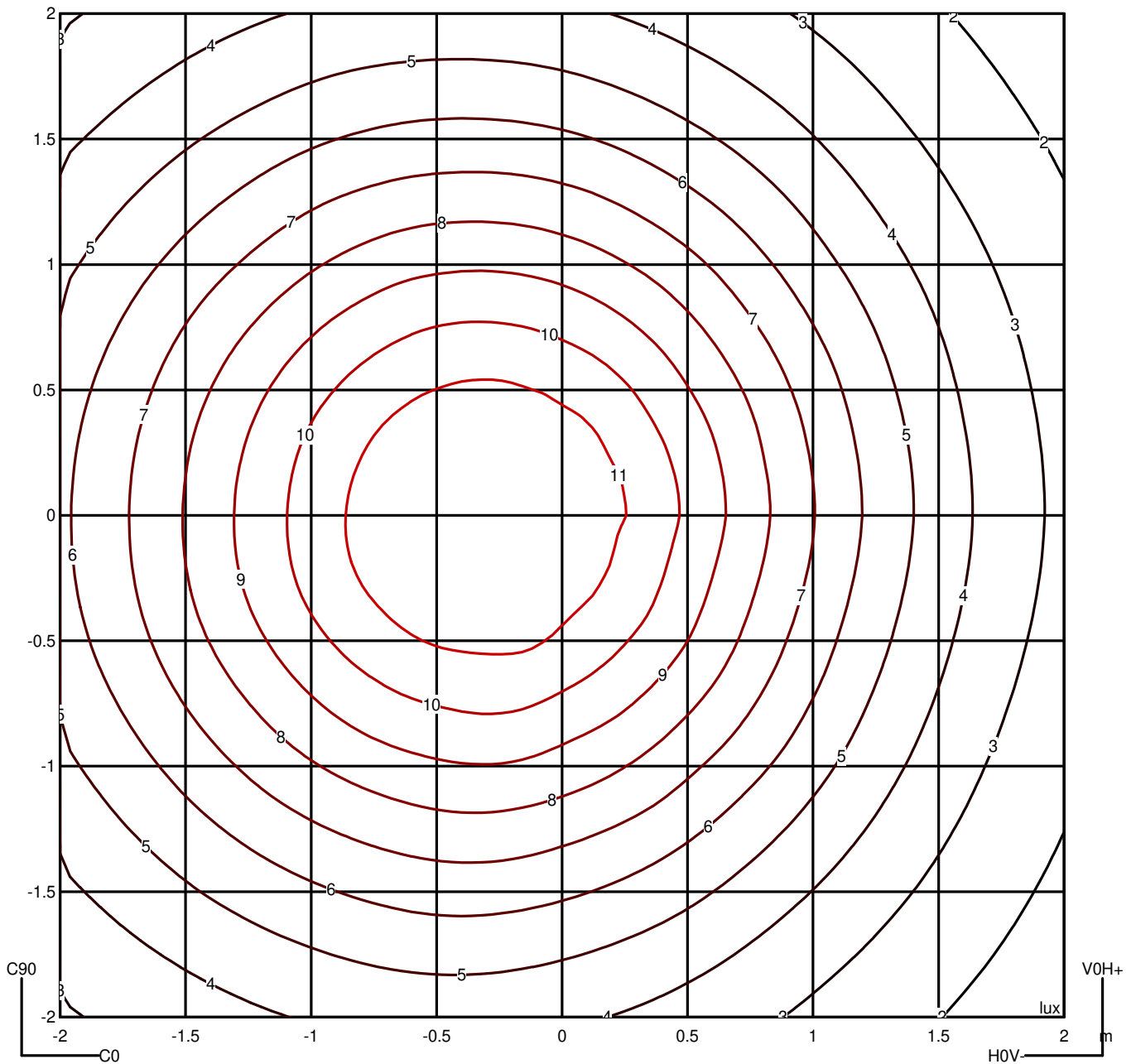

LEDS C4[®]

Luminaire

Code PX-0525-ANT
Name KAPA

Measurem.

Code PX-0525-ANT
Name KAPA

Luminaire Flux	443.60 lm	Luminaire Power	10.30 W	Efficacy	43.07 lm/W	Efficiency	100.00%
Sources Flux	443.60 lm	Maximum value	183.99 cd/klm	Position	C=175.00 G=159.00	CG	Asymmetrical

Luminance

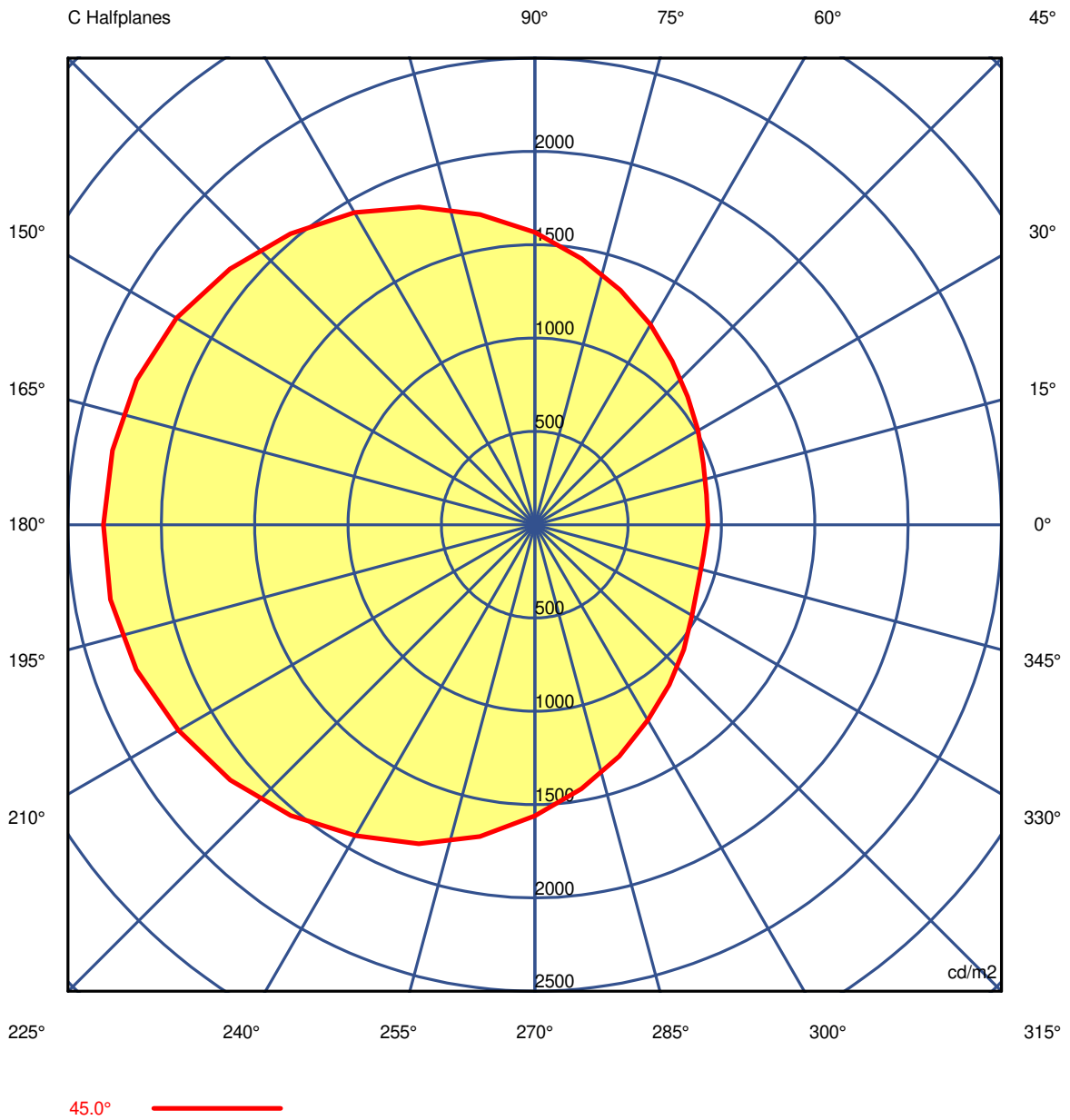

LEDS C4⁺

Luminaire

Code PX-0525-ANT
Name KAPA

Measurement

Code PX-0525-ANT
Name KAPA

Luminaire Flux	443.60 lm	Luminaire Power	10.30 W	Efficacy	43.07 lm/W	Efficiency	100.00%
Sources Flux	443.60 lm	Maximum value	183.99 cd/klm	Position	C=175.00 G=159.00	CG	Asymmetrical

Luminance cd/m2 Table 1/3

	C 0.00	C 10.00	C 20.00	C 30.00	C 40.00	C 50.00	C 60.00	C 70.00	C 80.00	C 90.00	C 100.00	C 110.00	C 120.00
G 0.0	1679.23	1679.47	1678.80	1677.00	1674.39	1670.90	1670.19	1675.46	1673.61	1664.13	1659.96	1661.15	1663.57
G 5.0	1605.25	1606.48	1608.03	1610.64	1615.24	1621.74	1632.15	1647.55	1656.69	1661.35	1674.34	1688.36	1699.13
G 10.0	1527.62	1528.95	1533.12	1541.92	1555.62	1572.61	1592.85	1616.68	1638.20	1657.31	1680.32	1709.25	1737.60
G 15.0	1449.85	1453.22	1461.79	1475.89	1492.88	1517.07	1548.83	1583.01	1615.55	1648.87	1688.64	1729.41	1766.41
G 20.0	1371.81	1374.59	1385.87	1406.31	1431.15	1464.55	1505.63	1548.14	1594.02	1643.28	1693.02	1744.56	1796.10
G 25.0	1292.33	1295.90	1310.76	1336.64	1366.00	1407.24	1459.06	1510.82	1569.20	1633.55	1695.29	1760.41	1825.86
G 30.0	1212.31	1216.26	1232.86	1262.96	1299.40	1349.14	1410.28	1472.93	1544.42	1621.78	1693.47	1771.58	1852.73
G 35.0	1124.67	1130.17	1150.62	1186.67	1229.41	1287.50	1359.10	1432.09	1512.99	1602.54	1693.15	1785.90	1877.22
G 40.0	1032.82	1037.52	1061.11	1103.74	1153.09	1220.36	1303.79	1388.51	1482.59	1585.83	1688.02	1794.83	1902.47
G 45.0	926.80	933.50	960.66	1009.77	1068.66	1145.33	1238.70	1337.64	1447.54	1567.13	1687.46	1811.68	1932.54
G 50.0	804.35	812.87	845.56	903.20	970.41	1058.78	1166.56	1278.36	1404.96	1543.98	1679.70	1821.28	1962.54
G 55.0	662.88	672.71	709.56	774.96	852.61	954.90	1079.20	1208.25	1355.24	1516.71	1673.00	1836.37	1999.93
G 60.0	495.43	505.99	548.00	622.97	711.01	824.02	963.69	1118.10	1293.76	1482.04	1663.62	1854.56	2045.51
G 65.0	302.45	314.55	361.42	439.64	523.69	648.85	819.09	1002.46	1209.87	1434.54	1651.58	1878.18	2104.01
G 70.0	98.34	114.63	151.24	212.27	295.77	437.58	633.87	846.52	1095.65	1372.07	1637.76	1914.53	2190.35
G 75.0	48.63	61.78	42.37	13.77	46.67	177.96	391.36	641.99	944.83	1285.02	1620.34	1977.81	2340.01
G 80.0	54.21	69.46	47.61	9.51	8.70	27.37	62.65	319.95	720.81	1175.64	1634.69	2133.66	2638.98
G 85.0	124.05	143.62	100.93	28.58	27.46	31.42	20.77	35.89	361.19	1038.42	1848.40	2730.92	3621.14
G 90.0	0.00	0.00	0.00	0.00	0.00	0.00	0.00	0.00	0.00	0.00	0.00	0.00	0.00

LEDS C4⁺

Luminaire

Code PX-0525-ANT
Name KAPA

Measurement

Code PX-0525-ANT
Name KAPA

Luminaire Flux	443.60 lm	Luminaire Power	10.30 W	Efficacy	43.07 lm/W	Efficiency	100.00%
Sources Flux	443.60 lm	Maximum value	183.99 cd/klm	Position	C=175.00 G=159.00	CG	Asymmetrical

Luminance cd/m2 Table 2/3

	C 130.00	C 140.00	C 150.00	C 160.00	C 170.00	C 180.00	C 190.00	C 200.00	C 210.00	C 220.00	C 230.00	C 240.00	C 250.00
G 0.0	1663.42	1663.17	1663.05	1663.70	1670.33	1679.23	1679.27	1678.46	1677.00	1674.45	1670.87	1670.19	1675.46
G 5.0	1709.67	1719.47	1728.13	1736.49	1745.95	1753.58	1753.71	1747.73	1739.70	1732.38	1719.94	1706.62	1701.55
G 10.0	1756.01	1772.60	1790.62	1805.39	1817.73	1826.24	1826.71	1818.17	1802.69	1783.88	1762.57	1742.02	1724.22
G 15.0	1798.81	1827.16	1851.56	1871.61	1887.92	1898.12	1897.67	1886.37	1866.08	1839.04	1805.92	1773.16	1746.55
G 20.0	1842.38	1881.59	1913.33	1937.84	1955.52	1965.51	1965.19	1950.25	1922.77	1889.28	1847.47	1802.62	1762.50
G 25.0	1880.23	1929.59	1973.79	2004.66	2024.37	2034.44	2032.55	2014.63	1981.93	1939.84	1887.91	1831.10	1776.02
G 30.0	1918.71	1977.78	2030.65	2066.91	2089.29	2101.23	2100.97	2077.76	2034.70	1985.74	1924.32	1854.44	1788.38
G 35.0	1958.47	2028.53	2087.79	2134.45	2160.11	2167.29	2165.22	2140.46	2091.51	2031.01	1957.50	1876.98	1799.35
G 40.0	1997.49	2082.04	2153.98	2204.11	2228.85	2235.40	2232.89	2202.21	2144.40	2079.68	1996.76	1900.67	1810.13
G 45.0	2035.67	2132.09	2216.83	2269.45	2297.27	2310.26	2308.43	2271.16	2203.25	2129.58	2034.56	1923.09	1818.63
G 50.0	2082.79	2190.07	2285.26	2355.20	2389.42	2396.00	2390.37	2348.27	2270.94	2184.61	2074.35	1946.59	1826.35
G 55.0	2138.71	2264.04	2375.70	2454.17	2487.64	2489.17	2481.42	2436.14	2351.37	2253.25	2125.01	1976.28	1837.40
G 60.0	2205.10	2350.91	2482.83	2574.17	2613.72	2617.39	2608.52	2551.26	2447.45	2334.90	2186.22	2008.69	1842.20
G 65.0	2294.67	2471.25	2632.29	2743.67	2789.10	2790.80	2782.41	2712.12	2580.91	2442.35	2264.66	2054.52	1857.06
G 70.0	2422.26	2639.09	2842.79	2992.24	3057.37	3059.14	3041.01	2948.66	2784.13	2606.60	2381.56	2118.23	1869.82
G 75.0	2647.84	2923.25	3186.25	3413.75	3507.85	3488.73	3462.45	3338.31	3109.68	2869.18	2571.60	2227.76	1907.89
G 80.0	3069.05	3505.50	3922.35	4173.86	4236.64	4203.98	4187.89	4045.04	3740.42	3380.09	2945.87	2462.66	2000.54
G 85.0	4432.86	5182.13	5842.87	6320.80	6527.97	6525.00	6439.30	6092.61	5506.78	4894.13	4127.17	3233.37	2406.33
G 90.0	0.00	0.00	0.00	0.00	0.00	0.00	0.00	0.00	0.00	0.00	0.00	0.00	0.00

LEDS C4[®]

Luminaire

Code PX-0525-ANT
Name KAPA

Measurem.

Code PX-0525-ANT
Name KAPA

Luminaire Flux	443.60 lm	Luminaire Power	10.30 W	Efficacy	43.07 lm/W	Efficiency	100.00%
Sources Flux	443.60 lm	Maximum value	183.99 cd/klm	Position	C=175.00 G=159.00	CG	Asymmetrical

Luminance cd/m2 Table 3/3

	C 260.00	C 270.00	C 280.00	C 290.00	C 300.00	C 310.00	C 320.00	C 330.00	C 340.00	C 350.00
G 0.0	1673.61	1664.13	1659.96	1661.14	1663.57	1663.42	1663.11	1663.05	1664.04	1669.47
G 5.0	1685.72	1659.77	1644.57	1634.98	1624.55	1613.21	1604.19	1597.75	1592.48	1594.88
G 10.0	1694.66	1656.81	1629.74	1606.65	1583.33	1563.38	1544.45	1527.69	1518.55	1519.46
G 15.0	1705.49	1652.33	1611.02	1574.27	1538.63	1509.77	1482.25	1457.31	1443.82	1442.84
G 20.0	1706.85	1639.79	1587.73	1540.70	1493.95	1454.58	1419.15	1388.12	1368.22	1364.08
G 25.0	1708.81	1632.32	1565.12	1501.61	1442.97	1398.09	1354.97	1314.24	1290.94	1285.99
G 30.0	1709.24	1618.68	1538.03	1463.42	1394.51	1337.44	1284.75	1238.26	1210.36	1204.05
G 35.0	1706.91	1602.38	1508.72	1420.58	1338.38	1271.25	1210.94	1158.54	1126.53	1117.78
G 40.0	1702.30	1580.19	1473.36	1372.71	1277.81	1201.20	1133.01	1073.12	1035.02	1024.23
G 45.0	1696.87	1559.63	1437.03	1319.70	1208.87	1119.78	1040.82	972.27	930.19	918.33
G 50.0	1686.78	1529.84	1388.84	1254.66	1128.62	1026.41	936.12	858.28	810.00	795.67
G 55.0	1673.68	1489.52	1329.63	1178.09	1032.77	913.37	809.73	722.43	668.07	652.19
G 60.0	1653.37	1444.63	1258.30	1078.86	909.09	774.41	658.59	560.54	501.02	484.08
G 65.0	1631.72	1382.18	1160.90	951.52	756.65	604.01	475.65	369.89	308.09	291.08
G 70.0	1596.38	1300.22	1033.53	784.35	559.28	388.24	254.11	152.20	97.53	85.39
G 75.0	1556.14	1179.37	854.65	560.70	300.81	121.37	39.06	27.51	34.17	42.21
G 80.0	1510.35	1008.51	584.14	235.86	18.13	25.75	33.73	42.07	43.94	47.73
G 85.0	1542.71	703.49	148.98	10.65	11.28	38.54	50.75	74.39	95.06	110.88
G 90.0	0.00	0.00	0.00	0.00	0.00	0.00	0.00	0.00	0.00	0.00



Kapa

PX-0468 PX-0525

FOR
LIGHT

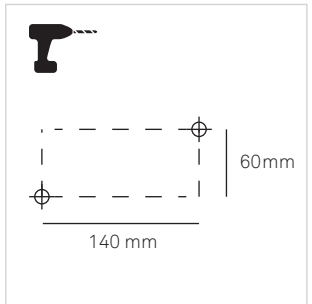

1

2

3

4

5

