

Data sheet | Item number: 221-415

COMPACT Splicing Connector; for all conductor types; max. 4 mm²; 5-conductor; with levers; transparent housing; Surrounding air temperature: max 85°C (T85); 4,00 mm²; transparent

www.wago.com/221-415

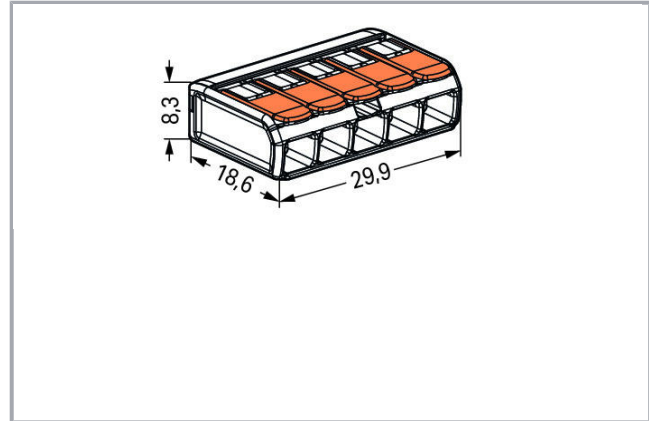

RoHS Compliant [BOMcheck.net](https://www.bomcheck.net)



Item description

Your Benefits:

- Easy to use: Pull the lever up, insert a conductor and push the lever back down
- Available as 2-, 3- and 5-wire connectors
- Easily terminate conductors from 0.14 to 4 mm², as well as solid and stranded conductors from 0.2 to 4 mm² (24 ... 12 AWG).

—
Subject to changes.

WAGO Kontakttechnik GmbH & Co. KG
Hansastr. 27
32423 Minden
Phone: +49571 887-0 | Fax: +49571 887-169
Email: info.de@wago.com | Web: www.wago.com

Do you have any questions about our products?
We are always happy to take your call at +49 (571) 887-44222.



- Time savings for installers and device manufacturers.
- Quickly install devices with higher levels of power consumption.
- Safely install long cable runs with larger conductor cross sections.
- Mounting carrier for installation conforming to standards
- Custom carriers are possible

Safety information 1:

In grounded power lines

Data**Electrical data****Ratings per IEC/EN 60664-1**

Rated voltage (II / 2)	450 V
Rated impulse voltage (II / 2)	4 kV
Rated current	32 A
Legend (ratings)	(II / 2) \triangleq Overvoltage category II / Pollution degree 2

Approvals per UL 1059

Rated voltage UL (Use Group C)	600 V
Rated current UL (Use Group C)	20 A

Connection data

Connection technology	CAGE CLAMP®
Actuation type	Lever
Connectable conductor materials	Copper
Nominal cross section	4 mm ²
Solid conductor	0.2 ... 4 mm ² / 24 ... 12 AWG
Stranded conductor	0.2 ... 4 mm ² / 24 ... 12 AWG
Fine-stranded conductor	0.14 ... 4 mm ² / 24 ... 12 AWG
Strip length	11 mm / 0.43 inch
Total number of connection points	5
Total number of potentials	1
Type of wiring	Side-entry wiring

Subject to changes.

WAGO Kontakttechnik GmbH & Co. KG
 Hansastr. 27
 32423 Minden
 Phone: +49571 887-0 | Fax: +49571 887-169
 Email: info.de@wago.com | Web: www.wago.com

Do you have any questions about our products?
 We are always happy to take your call at +49 (571) 887-44222.

Geometrical Data

Width	29.9 mm / 1.177 inch
Height	8.3 mm / 0.327 inch
Depth	18.6 mm / 0.732 inch

Material Data

Color	transparent
Flammability class per UL94	V2
Weight	4 g

Environmental Requirements



Surrounding air (operating) temperature	85 °C
Continuous operating temperature	105 °C
T-Marking per EN 60998	T85

Commercial data

Product Group	7 (Push Wire Conn.)
Packaging type	BOX
Country of origin	DE
GTIN	4055143234658
Customs Tariff No.	85369010000

Approvals / Certificates



Country specific Approvals

Logo	Approval	Additional Approval Text	Certificate name
	CCA DEKRA Certification B.V.	EN 60998	NTR NL- 7642
	CCA DEKRA Certification B.V.	EN 60998	71- 101731



Ship Approvals

Certificate

Subject to changes.





Logo	Approval	Additional Approval Text	name
	ABS American Bureau of Shipping	-	18- HG1755093- PDA
	DNV GL Det Norske Veritas, Germanischer Lloyd	EN 60998	TAE000015T
	LR Lloyds Register	EN 60998	04/20013 (E8)

UL-Approvals





Logo	Approval	Additional Approval Text	Certificate name
	UL Underwriters Laboratories Inc.	UL 467	E201573
	UL Underwriters Laboratories Inc.	UL 486C	E69654

Compatible products

Mounting adapter

	Item no.: 221-500 Mounting carrier; 221 Series - 4 mm ² ; for DIN-35 rail mounting/screw mounting; orange	www.wago.com/221-500
	Item no.: 221-500/000-006 Mounting carrier; 221 Series - 4 mm ² ; for DIN-35 rail mounting/screw mounting; blue	www.wago.com/221-500/000-006
	Item no.: 221-500/000-053 Mounting carrier; 221 Series - 4 mm ² ; for DIN-35 rail mounting/screw mounting; dark gray-yellow	www.wago.com/221-500/000-053
	Item no.: 221-505 Mounting carrier; for 5-conductor terminal blocks; 221 Series - 4 mm ² ; for screw mounting; white	www.wago.com/221-505

Subject to changes.

	Item no.: 221-505/000-004 Mounting carrier; for 5-conductor terminal blocks; 221 Series - 4 mm ² ; for screw mounting; black	www.wago.com/221-505/000-004
	Item no.: 221-515 Mounting carrier; for 5-conductor terminal blocks; 221 Series - 4 mm ² ; with snap-in mounting foot for horizontal mounting; white	www.wago.com/221-515
	Item no.: 221-515/000-004 Mounting carrier; for 5-conductor terminal blocks; 221 Series - 4 mm ² ; with snap-in mounting foot for horizontal mounting; black	www.wago.com/221-515/000-004
	Item no.: 221-525 Mounting carrier; for 5-conductor terminal blocks; 221 Series - 4 mm ² ; with snap-in mounting foot for vertical mounting; white	www.wago.com/221-525
	Item no.: 221-525/000-004 Mounting carrier; for 5-conductor terminal blocks; 221 Series - 4 mm ² ; with snap-in mounting foot for vertical mounting; black	www.wago.com/221-525/000-004

Downloads

Documentation

Additional Information

Technical explanations	3/abr/2019	pdf 2.1 MB	Download
------------------------	------------	---------------	----------

CAD/CAE-Data

CAD data

2D/3D Models 221-415	URL	Download
----------------------	-----	----------

CAE data

EPLAN Data Portal 221-415	Download
---------------------------	----------

Installation Notes

Subject to changes.

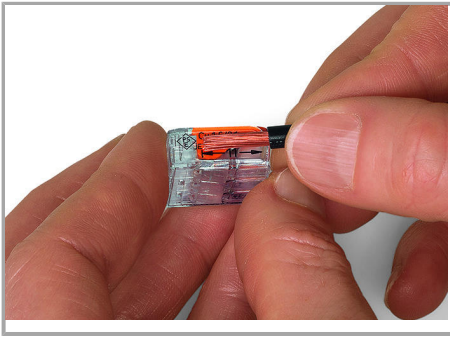

Strip conductor to 11 mm (0.43 inch).

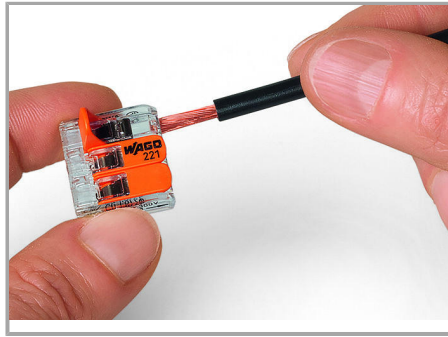

Termination: Lift the lever to open the clamping unit and insert a stripped conductor.

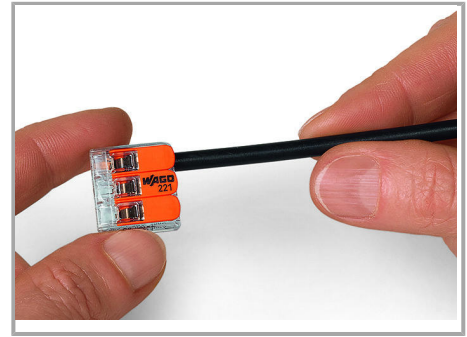

Then, lower the lever to close the clamp.

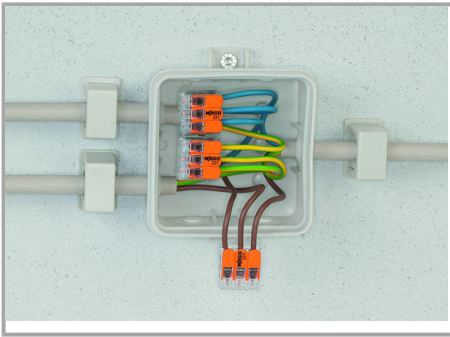

Wiring fine-stranded conductors in a junction box.



Custom low-voltage lighting system



Lighting distribution in ceiling canopy



Pendant light connection in suspended ceilings

Subject to changes.

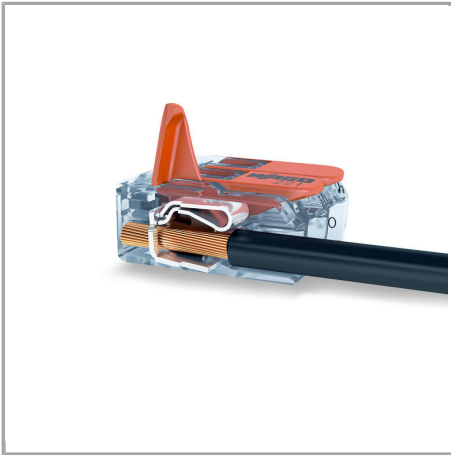

COMPACT Splicing Connectors for All
Conductor Types, 4 mm² (12 AWG), 221
Series

Subject to changes.