

CAÇONETES REDONDOS - BSP

ROSCA DIREITA

ROSCA ESQUERDA

INOX

G-Rohr (BSP)

British standard whitworth pipe thread
DIN ISO 228

Round Dies

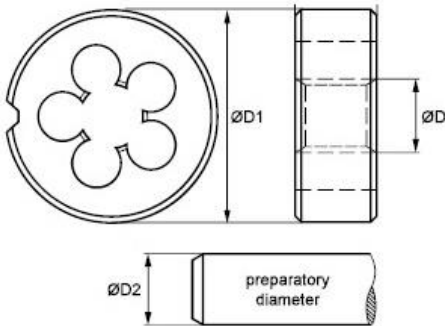

Round Dies
for general use



material: HSS A

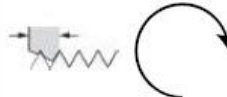

Chamfer: 1.5 threads right hand thread



Round Dies
for general use
Left Hand



material: HSS A

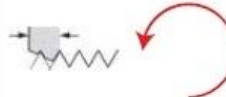

Chamfer: 1.5 threads left hand thread



Round Dies
for stainless steels



material: HSSE A



Chamfer: 1.5 threads right hand thread



with spiral entry



G(BSP)

	D	D1	H	D2	No.	€	No.	€	No.	€
BSP 1/8 x 28	9,73	30	11	9,62	131401001	17,26	131402001	31,18	131405001	27,28
BSP 1/4 x 19	13,16	38	10	13,03	131401002	17,60	131402002	35,64	131405002	27,28
BSP 3/8 x 19	16,66	45	14	16,54	131401003	23,38	131402003	52,34	131405003	40,65
BSP 1/2 x 14	20,95	45	14	20,81	131401004	23,38	131402004	52,34	131405004	40,65
BSP 5/8 x 14	22,91	55	16	22,77	131401005	42,32	131402005	70,72		
BSP 3/4 x 14	26,44	55	16	26,30	131401006	42,32	131402006	87,98	131405005	74,63
BSP 7/8 x 14	30,20	65	18	30,06	131401007	56,80	131402007	96,89		
BSP 1" x 11	33,25	65	18	33,07	131401008	56,80	131402008	96,89	131405006	106,92
BSP 1.1/8 x 11	37,90	75	20	37,72	131401009	95,79	131402009	122,51		
BSP 1.1/4 x 11	41,91	75	20	41,73	131401010	95,79	131402010	122,51		
BSP 1.3/8 x 11	44,32	90	22	44,14	131401011	167,07	131402011	202,70		
BSP 1.1/2 x 11	47,80	90	22	47,62	131401012	167,07	131402012	202,70		
BSP 1.5/8 x 11	52,00	90	22	51,82	131401013	167,07	131402013	202,70		
BSP 1.3/4 x 11	53,74	105	22	53,57	131401014	286,24	131402014	347,49		
BSP 2" x 11	59,61	90	22	59,43	131401015	167,07	131402015	347,49		
BSP 2" x 11	59,61	105	22	59,43	131401016	286,24				
BSP 2.1/4 x 11	65,71	120	22	65,49	131401017	389,82				
BSP 2.1/2 x 11	75,18	120	22	74,97	131401018	521,24				
BSP 2.3/4 x 11	81,53	120	22	81,32	131401019	521,24				
BSP 3" x 11	87,88	130	25	87,67	131401020	576,91				
BSP 3.1/2 x 11	100,33	150	25	100,11	131401021	935,52				
BSP 4" x 11	113,03	160	25	112,81	131401022	1158,31				

G-Rohr (BSP)

British standard whitworth pipe thread
DIN ISO 228

Hexagon Die Nuts

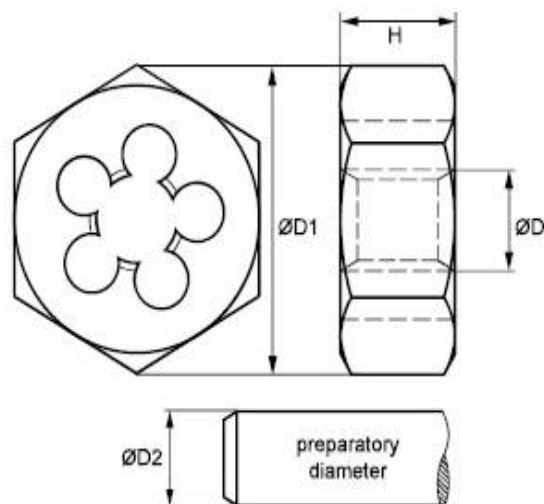

Hexagon Die Nuts
for general use

Hexagon Die Nuts
for general use
Left Hand

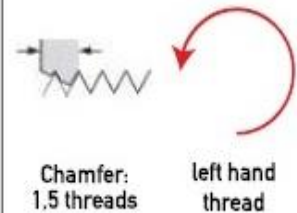
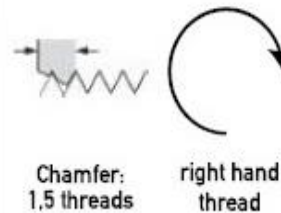
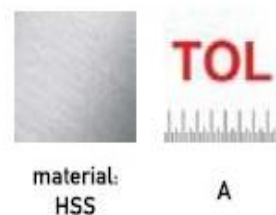

G(BSP)

D D1 H D2

No.

€

No.

€

G(BSP)	D	D1	H	D2	No.	€	No.	€
BSP 1/8 x 28	9,73	27	11	9,62	131501001	19,95	131502001	34,52
BSP 1/4 x 19	13,16	36	10	13,03	131501002	23,82	131502002	38,98
BSP 3/8 x 19	16,66	41	14	16,54	131501003	35,46	131502003	58,48
BSP 1/2 x 14	20,95	41	14	20,81	131501004	35,46	131502004	58,48
BSP 5/8 x 14	22,91	50	16	22,77	131501005	59,28	131502005	77,96
BSP 3/4 x 14	26,44	50	16	26,30	131501006	59,28	131502006	77,96
BSP 7/8 x 14	30,20	60	18	30,06	131501007	80,34		
BSP 1" x 11	33,25	60	18	33,07	131501008	80,34	131502007	100,24
BSP 1,1/8 x 11	37,90	70	20	37,72	131501009	118,57	131502008	155,92
BSP 1,1/4 x 11	41,91	70	20	41,73	131501010	118,57	131502009	155,92
BSP 1,3/8 x 11	44,32	85	22	44,14	131501011	197,26	131502010	257,28
BSP 1,1/2 x 11	47,80	85	22	47,62	131501012	197,26	131502011	257,28
BSP 1,5/8 x 11	52,00	85	22	51,82	131501013	197,26		
BSP 1,3/4 x 11	53,74	100	22	53,57	131501014	295,88	131502012	386,46
BSP 2" x 11	59,61	100	22	59,43	131501015	295,88	131502013	386,46

TARRACHAS MACHOS E CAÇONETES - BSP

Hand-Tap Sets, Round Dies and Tools Sets

British standard whitworth pipe thread DIN ISO 228

**G-Rohr
(BSP)**



Set G(BSP) 1/8" - 1"		€/Set
HSSG Hand Tap Sets & HSS Round Dies & Tools		
HSSG Hand Tap Sets (2 parts)	G 1/8 x 28 G 1/4 x 19 G 3/8 x 19 G 1/2 x 14 G 3/4 x 14 G 1" x 11	631,50 € Item No.: 264802014
HSS Round Dies	G 1/8 x 28 G 1/4 x 19 G 3/8 x 19 G 1/2 x 14 G 3/4 x 14 G 1" x 11	
adjustable Tap Wrenches - zinc die cast	M 1-10 1/16-3/8 G 1/8 & M 5-20 7/32-3/4" G 1/8-1/2 & M 13-32 1/2-1,1/4" G 1/4-1"	
Die Stocks - zinc die cast	30 x 11 38 x 10 45 x 14 55 x 16 68 x 18	
Screw extractor		

Set G(BSP) 1/8" - 1" (incl. intermediate sizes)		€/Set
HSSG Hand Tap Sets & HSS Round Dies & Tools		
HSSG Hand Tap Sets (2 parts)	G 1/8 x 28 G 1/4 x 19 G 3/8 x 19 G 1/2 x 14 G 5/8 x 14 G 3/4 x 14 G 7/8 x 14 G 1" x 11	846,50 € Item No.: 264802114
HSS Round Dies	G 1/8 x 28 G 1/4 x 19 G 3/8 x 19 G 1/2 x 14 G 5/8 x 14 G 3/4 x 14 G 7/8 x 14 G 1" x 11	
adjustable Tap Wrenches - zinc die cast	M 1-10 1/16-3/8 G 1/8 & M 5-20 7/32-3/4" G 1/8-1/2 & M 13-32 1/2-1,1/4" G 1/4-1"	
Die Stocks - zinc die cast	30 x 11 38 x 10 45 x 14 55 x 16 68 x 18	
Screw extractor		

Set G(BSP) 1/4" - 1.1/2"		€/Set
HSSG Hand Tap Sets & HSS Round Dies & Tools		
HSSG Hand Tap Sets (2 parts)	G 1/4 x 19 G 3/8 x 19 G 1/2 x 14 G 3/4 x 14 G 1" x 11 G 1,1/4" x 11 G 1,1/2" x 11	1700,00 € Item No.: 264802214
HSS Round Dies	G 1/4 x 19 G 3/8 x 19 G 1/2 x 14 G 3/4 x 14 G 1" x 11 G 1,1/4" x 11 G 1,1/2" x 11	
adjustable Tap Wrenches - zinc die cast	M 4-12 5/32-1/2 G 1/8 & M 11-27 7/16-1" G 1/4-3/4 & M 27-52 1,1/8"-2" G 3/4-1,3/4"	
Die Stocks - zinc die cast	38 x 10 45 x 14 55 x 16 68 x 18 75 x 20 90 x 22	
Screw extractor		

BAER Taps and Dies Sets
(example picture)

British standard whitworth pipe thread
DIN ISO 228



Set G(BSP) 1/8" - 3/4"		€/Set
Short Machine Taps through hole & blind hole HSSG Hexagonal-Die-Nuts		
HSSG Short Machine Taps Form D for through holes and blind holes (up to 4 x D)	G 1/8 x 28 G 1/4 x 19 G 3/8 x 19 G 1/2 x 14 G 3/4 x 14	199,08 € Item No.: BSR1
HSSG Hexagonal-Die-Nuts	G 1/8 x 28 G 1/4 x 19 G 3/8 x 19 G 1/2 x 14 G 3/4 x 14	

Set G(BSP) 1/8" - 1/2"		€/Set
Short Machine Taps through hole & blind hole HSSG Hexagonal-Die-Nuts		
HSSG Short Machine Taps Form D for through holes and blind holes (up to 4 x D)	G 1/8 x 28 G 1/4 x 19 G 3/8 x 19 G 1/2 x 14	151,73 € Item No.: BSR2
HSSG Hexagonal-Die-Nuts	G 1/8 x 28 G 1/4 x 19 G 3/8 x 19 G 1/2 x 14	
Attention: the box two empty spaces/ recesses for BSP3/4 Tap and Round Die in case of adding them later		

BAER Set G(BSP) 1/8" - 3/4"		€/Set
Short Machine Taps through hole & blind hole HSSG Round Dies		
BAER HSSG Short Machine Taps Form D for through holes and blind holes (up to 4 x D)	G 1/8 x 28 G 1/4 x 19 G 3/8 x 19 G 1/2 x 14 G 3/4 x 14	233,10 € Item No.: BSR1
BAER HSSG Round Dies	G 1/8 x 28 G 1/4 x 19 G 3/8 x 19 G 1/2 x 14 G 3/4 x 14	

JOGOS MACHOS DIN-5157- BSP

HSS DIREITO

HSS ESQUERDO

HSSE

G-Rohr (BSP)

British standard whitworth pipe thread
DIN ISO 228

Efficient internal thread cutting.
The short structural type makes that tap usable by hand.

A Hand-Tap-Set includes 2 taps:
Taper Tap
Finish Tap

Hand Tap Sets

for general use

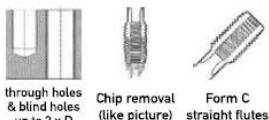

Hand Tap Sets

for general use

Left Hand

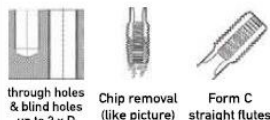

Hand Tap Sets

for high tensile materials

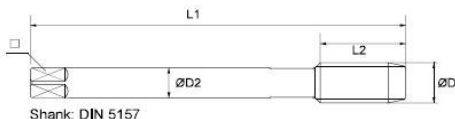
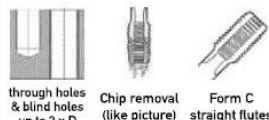

Shank: DIN 5157



G(BSP)	D1	D2	L1	L2	□	✂	No.	€	No.	€	No.	€
BSP 1/8 x 28	9,73	7,0	63	20	5,5	8,80	130301001	12,19	130302001	18,62	130304001	17,73
BSP 1/4 x 19	13,16	11,0	70	22	9,0	11,80	130301002	13,74	130302002	21,05	130304002	22,16
BSP 3/8 x 19	16,66	12,0	70	22	9,0	15,25	130301003	19,94	130302003	30,37	130304003	31,47
BSP 1/2 x 14	20,95	16,0	80	22	12,0	19,00	130301004	28,36	130302004	39,45	130304004	48,76
BSP 5/8 x 14	22,91	18,0	80	22	14,5	21,00	130301005	40,12	130302005	60,51		
BSP 3/4 x 14	26,44	20,0	90	22	16,0	24,50	130301006	40,12	130302006	60,51	130304005	59,17
BSP 7/8 x 14	30,20	22,0	90	22	18,0	28,25	130301007	67,60				
BSP 1" x 11	33,25	25,0	100	25	20,0	30,75	130301008	67,60	130302007	102,39	130304006	101,94
BSP 1,1/8 x 11	37,90	28,0	125	40	22,0	35,30	130301009	117,46	130302008	177,30		
BSP 1,1/4 x 11	41,91	32,0	125	40	24,0	39,50	130301010	117,46	130302009	177,30		
BSP 1,3/8 x 11	44,32	36,0	140	40	29,0	41,70	130301011	160,67	130302010	234,92		
BSP 1,1/2 x 11	47,80	36,0	140	40	29,0	45,25	130301012	160,67	130302011	234,92		
BSP 1,5/8 x 11	52,00	40,0	140	40	32,0	49,60	130301013	321,36				
BSP 1,3/4 x 11	53,74	40,0	140	40	32,0	51,20	130301014	321,35	130302012	483,13		
BSP 2" x 11	59,61	45,0	160	40	35,0	57,00	130301015	332,46	130302013	483,13		
BSP 2,1/4 x 11	65,71	50,0	160	40	39,0	63,10	130301016	726,96				
BSP 2,1/2 x 11	75,18	50,0	160	40	39,0	72,60	130301017	1019,50				
BSP 2,3/4 x 11	81,53	50,0	160	40	39,0	79,00	130301018	1702,15				
BSP 3" x 11	87,88	50,0	160	40	39,0	85,50	130301019	1983,46				
BSP 3,1/2 x 11	100,3	56,0	180	45	44,0	98,00	130301020	3124,80				
BSP 4" x 11	113,0	56,0	180	45	44,0	110,50	130301021	3900,62				

MACHO CURTO DE MAQUINA - BSP

G-Rohr (BSP)

British standard whitworth pipe thread
DIN ISO 228

Short Machine Taps

Efficient internal thread cutting.
The short structural type makes that tap usable by machine and hand.

Application:
non abrasive material up to 900 N/mm²
unalloyed and low alloyed steel

Short Machine Taps
Form D for through holes and blind holes

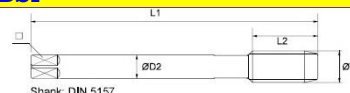
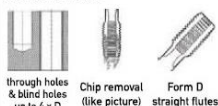

Shank: DIN 5157

G(BSP)	D1	D2	L1	L2	□	✂	No.	€
BSP 1/8 x 28	9,73	7,0	63	20	5,5	8,80	130101001	6,09
BSP 1/4 x 19	13,16	11,0	70	22	9,0	11,80	130101002	6,86
BSP 3/8 x 19	16,66	12,0	70	22	9,0	15,25	130101003	9,98
BSP 1/2 x 14	20,95	16,0	80	22	12,0	19,00	130101004	14,18
BSP 3/4 x 14	26,44	20,0	90	22	16,0	24,50	130101005	20,05
BSP 1" x 11	33,25	25,0	100	25	20,0	30,75	130101006	33,80
BSP 1,1/4 x 11	41,91	32,0	125	40	24,0	39,50	130101007	58,73
BSP 1,1/2 x 11	47,80	36,0	140	40	29,0	45,25	130101008	80,34
BSP 1,3/4 x 11	53,74	40,0	140	40	32,0	51,20	130101009	160,67
BSP 2" x 11	59,61	45,0	160	40	35,0	57,00	130101010	166,22
BSP 2,1/4 x 11	65,71	50,0	160	40	39,0	63,10	130101011	363,47
BSP 2,1/2 x 11	75,18	50,0	160	40	39,0	72,60	130101012	509,75
BSP 2,3/4 x 11	81,53	50,0	160	40	39,0	79,00	130101013	851,08
BSP 3" x 11	87,88	50,0	160	40	39,0	85,50	130101014	991,73
BSP 3,1/2 x 11	100,3	56,0	180	45	44,0	98,00	130101015	1562,40
BSP 4" x 11	113,0	56,0	180	45	44,0	110,50	130101016	1950,32

MACHOS MAQUINA DIN-5156- BSP

G-Rohr (BSP)

British standard whitworth pipe thread
DIN ISO 228

Tap for machine use in through hole and for left-hand thread in through and blind holes.
The spiral point pushes the chips ahead.

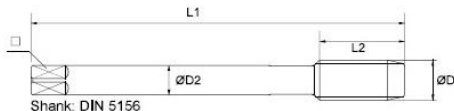

HSS DIREITO

Machine Tap for general use

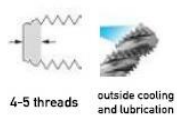
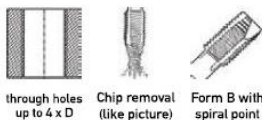

P/ INOX

Machine Tap for stainless steels

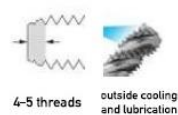
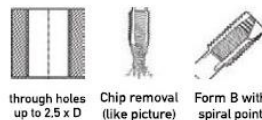

HSS ESQUERDO

Machine Tap for general use
Left-hand thread

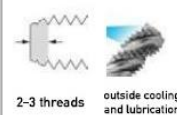
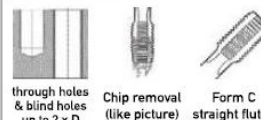

G(BSP)	D1	D2	L1	L2	□	✎	No.	€	No.	€	No.	€
BSP 1/8 x 28	9,73	7,0	90	20	5,5	8,80	130401001	15,59	130405001	35,33	130502001	22,27
BSP 1/4 x 19	13,16	11,0	100	22	9,0	11,80	130401002	19,71	130405002	51,61	130502002	27,51
BSP 3/8 x 19	16,66	12,0	100	22	9,0	15,25	130401003	23,39	130405003	59,37	130502003	34,52
BSP 1/2 x 14	20,95	16,0	125	25	12,0	19,00	130401004	34,53	130405004	77,19	130502004	48,56
BSP 5/8 x 14	22,91	18,0	125	25	14,5	21,00	130401005	40,09	130405005	87,90	130502005	56,13
BSP 3/4 x 14	26,44	20,0	140	28	16,0	24,50	130401006	51,23	130405006	102,72	130502006	71,28
BSP 7/8 x 14	30,20	22,0	150	28	18,0	28,25	130401007	64,59	130405007	178,24		
BSP 1" x 11	33,25	25,0	160	30	20,0	30,75	130401008	80,19	130405008	219,88	130502007	71,84
BSP 1.1/8 x 11	37,90	28,0	170	30	22,0	35,30	130401009	118,06	130405009	274,46		
BSP 1.1/4 x 11	41,91	32,0	170	30	24,0	39,50	130401010	140,33	130405010	309,84		
BSP 1.3/8 x 11	44,32	36,0	180	32	29,0	41,70	130401011	186,00	130405011	377,44		
BSP 1.1/2 x 11	47,80	36,0	190	32	29,0	45,25	130401012	201,58	130405012	411,77		
BSP 1.3/4 x 11	53,74	40,0	190	32	32,0	51,20	130401013	291,79	130405013	529,78		
BSP 2" x 11	59,61	45,0	220	40	35,0	57,00	130401014	322,99	130405014	551,46		

MACHOS MAQUINA DIN-5156- BSP

HSS DIREITO

P/ INOX

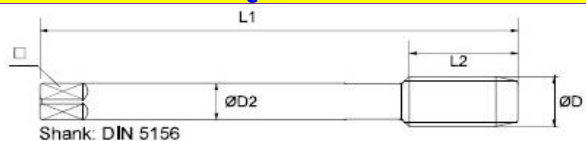

G(BSP)	D1	D2	L1	L2	□	✎	No.	€	No.	€
BSP 1/8 x 28	9,73	7,0	90	20	5,5	8,80	130601001	17,16	130605001	35,02
BSP 1/4 x 19	13,16	11,0	100	22	9,0	11,80	130601002	21,72	130605002	53,41
BSP 3/8 x 19	16,66	12,0	100	22	9,0	15,25	130601003	27,84	130605003	62,75
BSP 1/2 x 14	20,95	16,0	125	25	12,0	19,00	130601004	38,98	130605004	80,22
BSP 5/8 x 14	22,91	18,0	125	25	14,5	21,00	130601005	45,67	130605005	91,88
BSP 3/4 x 14	26,44	20,0	140	28	16,0	24,50	130601006	57,91	130605006	107,64
BSP 7/8 x 14	30,20	22,0	150	28	18,0	28,25	130601007	58,67	130605007	168,88
BSP 1" x 11	33,25	25,0	160	30	20,0	30,75	130601008	89,09	130605008	222,57
BSP 1.1/8 x 11	37,90	28,0	170	30	22,0	35,30	130601009	130,31	130605009	277,37
BSP 1.1/4 x 11	41,91	32,0	170	30	24,0	39,50	130601010	155,92	130605010	321,55
BSP 1.3/8 x 11	44,32	36,0	180	32	29,0	41,70	130601011	204,94	130605011	378,62
BSP 1.1/2 x 11	47,80	36,0	190	32	29,0	45,25	130601012	222,74	130605012	426,97
BSP 1.3/4 x 11	53,74	40,0	190	32	32,0	51,20	130601013	320,76	130605013	521,59
BSP 2" x 11	59,61	45,0	220	40	35,0	57,00	130601014	356,39	130605014	544,44

UNiForm Machine Forming Taps

G-Rohr (BSP)

British standard whitworth pipe thread
DIN ISO 228

Machine Forming Taps have following advantages:

- No chips
- Up to 20 times longer lifetime (compared to taps)
- Same forming tap for through and blind hole
- Wide range of materials can be processed
- Intersection of the thread is impossible
- Very high trueness
- Increased strength of the thread
- Higher surface quality
- Much higher cutting speed

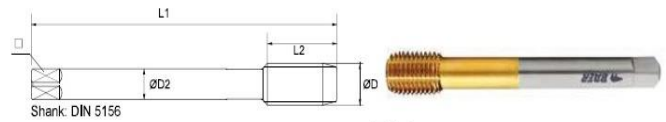

G(BSP)	D1	D2	L1	L2	□	□	No.	€
BSP 1/8 x 28	9,73	7,0	90	18	5,5	9,25	131101001	97,18
BSP 1/4 x 19	13,16	11,0	100	22	9,0	12,50	131101002	122,20
BSP 3/8 x 19	16,66	12,0	100	22	9,0	16,00	131101003	153,05
BSP 1/2 x 14	20,95	16,0	125	25	12,0	20,00	131101004	179,61
BSP 3/4 x 14	26,44	20,0	140	28	20,0	25,50	131101005	371,91